

Foreword

Thank you for purchasing your new Chery automobile. To correctly operate and maintain your vehicle and understand its features and controls, please take the time to read this manual carefully.

After you read this manual, it should be stored in the vehicle for convenient reference and remain with the vehicle when sold so that the new owner will be aware of all safety warnings.

Chery Automobile Co., Ltd. reserves the right to make changes in design and specifications, and / or make additions to or improvement to its products without imposing any obligation upon itself to install them on products previously manufactured.

Authorized Chery dealers are service professionals and are exclusively authorized by Chery Automobile Co., Ltd. When it comes to service, remember that your authorized dealer knows your vehicle best, has the factory-trained technicians and OEM parts to best provide the customer satisfaction that you require.

Depending on the vehicle equipment or features specific to your vehicle, some descriptions and illustrations may differ from the equipment found on your vehicle.

Please access our website for further information.

Website: www.cheryinternational.com

© 2009 Chery Automobile Co., Ltd.

All rights reserved. This material may not be reproduced or copied, in whole or in part, without the written permission of Chery Automobile Co., Ltd.

TABLE OF CONTENTS

CHAPTER		PAGE
1	INTRODUCTION	3
2	BEFORE OPERATING YOUR VEHICLE	15
3	FEATURES OF YOUR VEHICLE	33
4	STARTING AND OPERATING YOUR VEHICLE	57
5	YOUR INSTRUMENT PANEL	77
6	IN CASE OF AN EMERGENCY	97
7	CUSTOMER ASSISTANCE	107
8	PROPER MAINTENANCE OF YOUR VEHICLE	111
9	MAINTENANCE SCHEDULES	129
10	INDEX	147

INTRODUCTION

CONTENTS

▶ Introduction	4	▶ Vehicle Features	6	▶ Personal Service	10
▶ How to Read This Manual	4	▶ New Vehicle Inspection	6	▷ "PERSON-TO-PERSON" Service Advisor Card	11
▷ Table of Contents	4	▷ Inspection Certification for Vehicle Delivery	7	▶ Warnings and Cautions	13
▷ Vehicle Symbols	4	▷ Vehicle Delivery Card	8	▶ Vehicle Identification Number	13
▷ Index	4			▶ Vehicle Modifications	13

Introduction

Congratulations on selecting your new Chery vehicle. To correctly operate and maintain your vehicle and understand its features and controls, please take the time to read this manual carefully.

This manual contains important instructions and tips concerning routine driving and regular maintenance of your vehicle. The more familiar you are with the operation of your vehicle, the more you will ensure your safety and overall economic benefit while driving. Failure to operate this vehicle correctly may result in loss of control or an accident.

Regular routine maintenance will keep your vehicle operating at its best. We suggest you have your vehicle serviced at recommended intervals by an authorized Chery dealer who uses authorized Chery replacement parts. Any damage caused by failing to follow recommended operation or maintenance may not be covered by your warranty.

How to Read This Manual

Table of Contents















































Consult the Table of Contents to determine which section of the Owner's Manual contains the information you desire.

Vehicle Symbols

Consult the symbol table on the following page for a description of the symbols that may be used on your vehicle and throughout the Owner's Manual.

Index

The detailed index at the back of this Owner's Manual contains a complete listing for all vehicle subject matter.

EPC ELECTRONIC THROTTLE CONTROL INDICATOR LIGHT	SRS AIRBAG SUPPLEMENTAL RESTRAINT SYSTEM	A/C AIR CONDITIONING SYSTEM	 CRUISE INDICATOR LIGHT	 REAR WINDOW WIPER SWITCH	 REAR FOG LIGHT	 FRONT FOG LIGHT
 ANTILOCK BRAKING SYSTEM (ABS)	 HIGH BEAM LAMP	 LOW BEAM LAMP	 CIGARETTE LIGHTER	 WARNING LIGHT FOR ENGINE OIL PRESSURE	 FUEL INDICATOR	 COOLANT TEMPERATURE INDICATOR
 BATTERY	 HEADLAMP SWITCH	 BRAKE SYSTEM WARNING LAMP	 FRONT WINDSHIELD WIPER AND WASHER	 HORN	 DUCKLE UP SEAT BELT	 HAZARD FLASHING WARNING LAMP
 INDICATOR LIGHT FOR AIR BAG	 UPPER AND LOWER AIR OUTLET	 UPPER AIR OUTLET	 LOWER AIR OUTLET	 DEFROST AND LOWER AIR OUTLET	 SEAT HEATING	 WINDSHIELD DEFROST/DEFOG
 PARKING BRAKE INDICATOR LAMP	 LOCK INDICATOR	 UNLOCK INDICATOR	 WARNING LIGHT HOOD	 VEHICLE MAINTENANCE INDICATOR	 MALFUNCTION INDICATOR LIGHT	 OUTDOOR REARVIEW MIRROR HEATING
 INDICATOR FOR INTERIOR LAMP SWITCH	 AUDIBLE ALARM	 WARNING INDICATOR FOR BRAKE PAD	 REAR WINDSHIELD HEATING INDICATOR	 HOOD RELEASE	 INTERIOR AIR FILTER	 HORN/WINDSHIELD WIPER
 PARK LIGHTS	 TURN SIGNALS	 POWER WINDOW LIFT	 REAR WINDSHIELD WIPER AND WASHER	 DOOR UNLOCK	 DOOR LOCK	 REAR WINDSHIELD WASHER

Item010001

Vehicle Features

This manual includes the current features and information regarding the Chery Tiggo. All material (including all standard and available features) contained in this publication is based on the latest information at the time it was printed. Therefore, please note that some of the equipment and ac-

cessories in this publication may not appear on your vehicle.

New Vehicle Inspection

Prior to your purchase, your authorized Chery dealer inspected your vehicle based upon the guidelines of the Chery Automobile Co., Ltd. The dealer will record the delivery date and affix its common seal to the inspection certificate.

Before you sign the inspection certification, your authorized dealer will instruct you regarding your vehicle's performance capabilities according to its Vehicle Delivery Card, as well as provide you with general knowledge of its features and regular operation.

8 – INTRODUCTION

Vehicle Delivery Card

Category	No.	Item	Operation confirmed	
			Yes <input type="checkbox"/>	No <input type="checkbox"/>
Overall Performance	1	Engine	Yes <input type="checkbox"/>	No <input type="checkbox"/>
	2	Engine oil, brake fluid, power steering fluid, coolant, battery electrolyte and windshield washer fluid	Yes <input type="checkbox"/>	No <input type="checkbox"/>
	3	VIN, engine code and nameplate	Yes <input type="checkbox"/>	No <input type="checkbox"/>
	4	Complete set of vehicle keys	Yes <input type="checkbox"/>	No <input type="checkbox"/>
	5	Headlamps, turn signal lamps, fog lamps, combination lamps, interior lamps, stop lamps, backup lamps, tail lamps, reading lamps, door lamps and instrument lamps	Yes <input type="checkbox"/>	No <input type="checkbox"/>
	6	Windshield and painted surfaces	Yes <input type="checkbox"/>	No <input type="checkbox"/>
	7	Speedometer, tachometer and odometer	Yes <input type="checkbox"/>	No <input type="checkbox"/>
	8	Spare tire, vehicle jack, tool and user's manual	Yes <input type="checkbox"/>	No <input type="checkbox"/>
	9	Seat, seat belt, cigarette lighter, A/C switch, glove box and sun visor	Yes <input type="checkbox"/>	No <input type="checkbox"/>
	10	Windows, rearview mirror, windshield wipers, windshield washers, horn, sunroof, parking sonar, on - board telephone, radio (CD) and antenna	Yes <input type="checkbox"/>	No <input type="checkbox"/>

beom010003

General Knowledge of Operation	1	No. 93 gasoline	Yes <input type="checkbox"/>	No <input type="checkbox"/>
	2	Normal operation during break - in period	Yes <input type="checkbox"/>	No <input type="checkbox"/>
	3	Operation of all vehicle lights	Yes <input type="checkbox"/>	No <input type="checkbox"/>
	4	Understanding warning lights	Yes <input type="checkbox"/>	No <input type="checkbox"/>
	5	Correct maintenance schedules time/mileage	Yes <input type="checkbox"/>	No <input type="checkbox"/>
	6	Vehicle maintenance in winter/summer	Yes <input type="checkbox"/>	No <input type="checkbox"/>
	7	Proper understanding of cooling system and use of proper coolant	Yes <input type="checkbox"/>	No <input type="checkbox"/>
	8	Correct operation of A/C	Yes <input type="checkbox"/>	No <input type="checkbox"/>
	9	Precautions during vehicle starting	Yes <input type="checkbox"/>	No <input type="checkbox"/>
	10	Correct operation of audio system	Yes <input type="checkbox"/>	No <input type="checkbox"/>
	11	Correct operation of sunroof	Yes <input type="checkbox"/>	No <input type="checkbox"/>
<p style="text-align: center;">Signature of Sales Clerk: Date: Signature of Customer: Date:</p>				

beom010004

Personal Service

To provide you the best service, your authorized Chery dealer will provide a personal service advisor for you during your purchase. If you have any questions regarding your vehicle, please ask your service advisor.

“PERSON-TO-PERSON” Service Advisor Card

“PERSON-TO-PERSON” ADVISORY SERVICE CARD

Name of Customer: _____ Date of Purchase: _____
 Dealer of Sales & Service: _____ Type: _____
 VIN of Vehicle: _____

The following should be completed by the customer:

I. Vehicle Delivery and Inspection (mark a "✓" for "Yes" and an "X" for other):

- Have reviewed the basic operation of the vehicle and performed the delivery inspection with the customer.
- Have reviewed and explained the warranty policy with the customer.
- Have discussed the precautions of driving with the customer.
- Have explained the importance of regular maintenance and the maintenance interval schedule.
- Have explained to the customer the importance of having regular maintenance performed at an authorized Chery dealer.
- Have delivered the Owner's Manual to the customer and reminded them to read it.
- Have explained the customer hotline number and operating information of Chery customer service to the customer.

II. Service Advisor Customer Service (mark a "✓" for "Yes" and an "X" for other):

- The service advisor was able to address all customer questions and concerns.
- The service advisor is the only person authorized by the dealer to answer customer questions.

- Each customer is assigned a specific service advisor for "Person - to - Person" service.
- If the customer is not completely satisfied with the service advisor, the customer can select another service advisor.

III. Service Advisor Availability (mark a "✓" for "Yes" and an "X" for other):

- Proper reception at time of service
- Accurately documents customer complaint
- Alerts customer of regularly scheduled maintenance
- Alerts customer of scheduled annual inspection
- Promptly schedules service appointments
- Promptly consults customer on maintenance and service items
- Other demands from customers

IV. Service Advisor Business Card.

Business Card of Service Advisor

Signature of Customer/Date: _____ Signature of Service Advisor/Date: _____

Sheet One

Kept by Service Station

beom010005

“PERSON-TO-PERSON” ADVISORY SERVICE CARD

Name of Customer: Date of Purchase:
Dealer of Sales & Service: Type:
VIN of Vehicle:

The following should be completed by the customer:

I. Vehicle Delivery and Inspection (mark a "✓" for "Yes" and an "X" for other):

- Have reviewed the basic operation of the vehicle and performed the delivery inspection with the customer.
- Have reviewed and explained the warranty policy with the customer.
- Have discussed the precautions of driving with the customer.
- Have explained the importance of regular maintenance and the maintenance interval schedule.
- Have explained to the customer the importance of having regular maintenance performed at an authorized Chery dealer.
- Have delivered the Owner's Manual to the customer and reminded them to read it.
- Have explained the customer hotline number and operating information of Chery customer service to the customer.

II. Service Advisor Customer Service (mark a "✓" for "Yes" and an "X" for other):

- The service advisor was able to address all customer questions and concerns.
- The service advisor is the only person authorized by the dealer to answer customer questions.

- Each customer is assigned a specific service advisor for "Person - to - Person" service.
- If the customer is not completely satisfied with the service advisor, the customer can select another service advisor.

III. Service Advisor Availability (mark a "✓" for "Yes" and an "X" for other):

- Proper reception at time of service
- Accurately documents customer complaint
- Alerts customer of regularly scheduled maintenance
- Alerts customer of scheduled annual inspection
- Promptly schedules service appointments
- Promptly consults customer on maintenance and service items
- Other demands from customers

IV. Service Advisor Business Card.



Signature of Customer/Date: Signature of Service Advisor/Date:

beom010006

Sheet Two

Kept by Customer

Warnings and Cautions

The Owner's Manual contains Warnings and Cautions regarding operating procedures that could result in an accident or damage to your vehicle. Please observe all Warnings and Cautions before operating your vehicle.

Vehicle Identification Number

Vehicle Identification Number (VIN) Location:

The VIN is on the front corner of the instrument panel on the passenger side. It is visible from outside of the vehicle through the windshield.

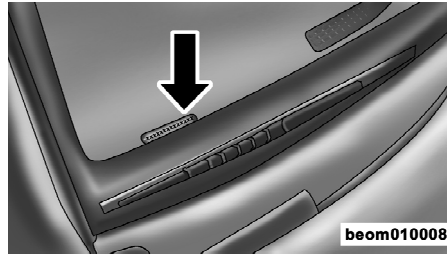

VIN Location

Vehicle Modifications

Modifications to this vehicle could affect its performance and totally void the manufacturer's warranty.

WARNING!

Any modifications or alterations to this vehicle could affect its safety and may lead to an accident resulting in serious injury or death.

BEFORE OPERATING YOUR VEHICLE

CONTENTS

▶ Ignition Key	17	▶ Steering Wheel	20	▶ Occupant Restraints	23
▷ Ignition Key Removal	17	▷ Adjusting Steering Wheel	20	▷ Lap/Shoulder Belts	23
▷ Key-In-Ignition Reminder	17	▷ Horn	20	▷ Lap/Shoulder Belt Warning Light	23
▷ Locking Doors With The Key	17	▶ Door Locks	20	▷ Lap/Shoulder Belt Operating Instructions	23
▷ Replacement Keys	17	▷ Manual Door Locks	20	▷ Central Two-Point Seat Belt for Rear Seat	24
▷ Remote Keyless Entry	18	▷ Power Door Locks	21	▷ Adjustable Upper Shoulder Belt Anchorage	24
▷ Transmitter Battery Replacement	18	▷ “Child-Protection” Door Lock System (Rear Doors)	21	▷ Maintenance for Seat Belt	24
▶ Anti-Theft Security Protection	19	▶ Power Windows	22	▷ Airbag	25
▷ Vehicle Alarm	19	▷ Power Window Switches	22	▷ Airbag Warning Light	26
▷ Electronic Key Identification	19	▷ Auto - Down Feature	22	▷ Child Restraint	26
		▷ Rear Window Safety Switch	23		

16 – BEFORE OPERATING YOUR VEHICLE

▶ Operating Safety Tips	28	▷ Exhaust Gas	28	▶ New Vehicle Break-In Recommendations	30
▷ Transporting Passengers	28	▷ Interior Vehicle Safety Inspection	29	▷ Engine Break-In Recommendations	30
▷ Locking Your Vehicle	28	▷ Exterior Vehicle Safety Inspection	29	▷ Braking System Break-In Recommendations	31
				▷ Tire and Wheel Break-In Recommendations	31

Ignition Key

Ignition Key Removal

Automatic Transaxle

To remove the ignition key from the ignition switch, place the shift lever in PARK, turn the ignition switch to the ACC position, push the key inward, rotate the key to the LOCK position and remove the key.

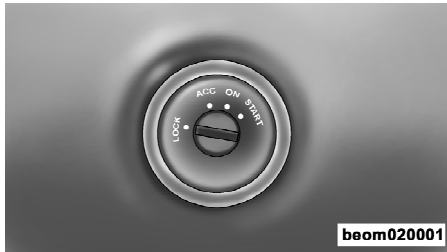

boom020001

Ignition Key Positions

⚠ WARNING!

NEVER leave children unattended in a vehicle. Leaving children unattended in a vehicle is dangerous. A child or others could be seriously or fatally injured. Children could operate the power windows, other controls, or set the vehicle in motion. **NEVER** leave the keys in a vehicle.

CAUTION!

An unlocked car is an invitation to thieves. Always remove the key from the ignition and lock all doors when leaving the vehicle unattended.

Key-In-Ignition Reminder

Opening the driver's door when the key is in the ignition will sound a signal to remind you to remove the key.

NOTE: If any of the five doors (front driver's door, front passenger's door, rear passenger doors and back cargo

door) is open or the key is in the ignition, this will prevent the operation of the power door locks and Remote Keyless Entry.

Locking Doors With The Key

There are three external door locks which are located on the driver's door, front passenger's door and back cargo door. You can insert the key with either side up. To lock the door, turn the key counter-clockwise; to unlock the door, turn the key clockwise.

Replacement Keys

Duplication of keys consists of programming a blank key to the vehicle electronics. A blank key is one which has never been programmed. See your authorized Chery dealer if you require replacement or additional keys for your vehicle.

CAUTION!

Always remove the key from the vehicle and lock all doors when leaving the vehicle unattended.

Remote Keyless Entry

This system allows you to lock or unlock the doors remotely using the key transmitter.



Item020009

Vehicle Key

To Lock the Doors

Press and release the LOCK button on the transmitter to lock all doors.

NOTE: Transmitter and receivers must be certified to conform to specific regulations in each individual country. Operation is subject to the following two conditions:

- The device cannot cause harmful interference.
- The device must accept any interference received, including interference that may cause undesired operation.

If your key transmitter fails to operate from a normal distance, check for these two conditions:

- Weak batteries in the transmitter (the expected life of the transmitter battery is a minimum of three years).
- Radio transmitter interference, such as a radio station tower, airport transmitter, and some mobile or CB radios.

Transmitter Battery Replacement

The recommended replacement battery is CR2032.

- With the transmitter buttons facing down, use a flat object to pry the two halves of the transmitter apart. Make sure not to damage the seal.



beam020018

Separating Transmitter Halves

- Remove and replace the batteries. Avoid touching the new batteries with your fingers. Skin oils may cause battery deterioration. If you touch a battery, clean it with rubbing alcohol.
- To reassemble the transmitter case, snap the two halves together.

Anti-Theft Security Protection

Vehicle Alarm

With the vehicle armed, if an unauthorized person attempts to unlock any door, this will cause the vehicle alarm to trigger. When triggered, the vehicle alarm will cause all directional signals to flash continuously and will sound the horn for a few seconds.

Security Lamp

The security lamp is located in the front of the instrument panel. The security lamp will flash continuously when the vehicle is armed.

WARNING!

Only when driver door, passenger doors and back door are fully closed, can the vehicle be armed. When the vehicle is in the anti-theft mode, the following will occur:

- **Driver door, passenger doors and back door are locked**
- **The security lamp will continuously flash**

Electronic Key Identification

Electronic Key Identification utilizes engine "no-start" technology to greatly enhance the vehicle safety and vehicle theft prevention system.

The chip, built into each key, integrates the key, electronic anti-theft equipment and engine control module into an active theft prevention system. If a key is duplicated without the authorization of the owner, and the key has no chip containing the electronic information required for the anti-theft equipment and engine computer, the engine will not start using the duplicated key, thus decreasing the probability of vehicle theft.

In the event that you have lost your vehicle key, you should go to an authorized Chery dealer to obtain a replacement key. The dealer can make a new key for your vehicle and deactivate your lost key.

Steering Wheel

Adjusting Steering Wheel

The steering wheel can be adjusted to make the driver more comfortable. Pull down the locking lever to move the steering wheel upward and downward. After the proper adjustment, pull the locking lever back to its original position to secure the steering wheel in place.

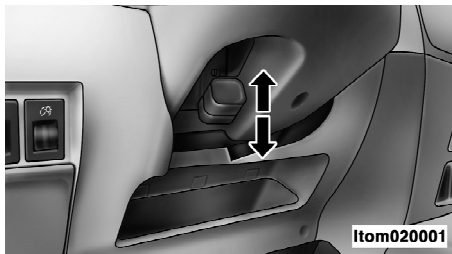

Adjustable Steering Wheel

⚠ WARNING!

Do not adjust the steering wheel while driving. Adjusting the steering wheel while driving could cause the driver to lose control of the vehicle.

Horn



Horn Position

Press the center push pad on the steering wheel to operate the horn. The horn will still work with the ignition switch in the OFF position.

Door Locks

Manual Door Locks

The front doors can be locked/unlocked by turning the key in the door lock cylinder. Use the manual door lock switch on the door panel to unlock the doors from inside of the vehicle. If the rear door switch is in the locked position when the door is closed, the door will lock. It is recommended to use the Remote Keyless Entry to lock the doors.

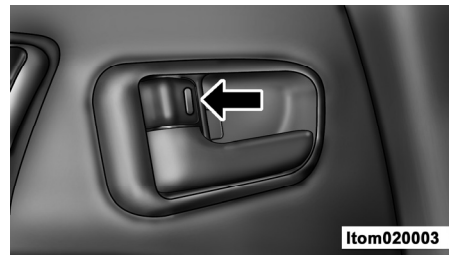

Manual Lock Switch

⚠ WARNING!

For personal security and safety lock the vehicle doors when you drive, as well as when you park and leave the vehicle. When leaving the vehicle, always remove the key from the ignition switch, and lock your vehicle. Do not leave children unattended in the vehicle, or with access to an unlocked vehicle. Unsupervised use of vehicle equipment may cause severe personal injuries or death.

Power Door Locks

A door lock switch is located on the driver's door panel. Press this switch to lock or unlock the doors.

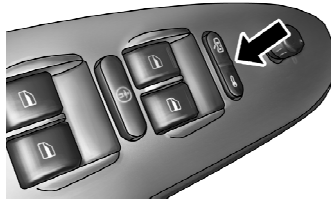

beom020004

Power Door Lock Switch

To prevent you from locking your key in the vehicle, the power door LOCK switch will not operate while the key is in the ignition and either front door is open. An audible chime will sound as a reminder to remove the key from the ignition switch.

NOTE: The doors will lock automatically on vehicles with power door locks when the vehicle speed is above 45 km/h. The auto lock feature is activated once the engine starts. The doors will unlock automatically on vehicles with

power door locks when the engine is turned off and the transaxle is in NEUTRAL or PARK.

“Child-Protection” Door Lock System (Rear Doors)

The Rear Door Child-Protection Locks are located inside the rear door. Turn the child lock control upward or downward to the lock or unlock position (as shown by the icons).

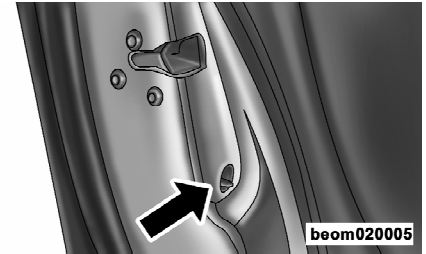

beom020005

Child Lock Control

⚠ WARNING!

- To avoid trapping passengers in the vehicle during a collision, remember that the rear doors can only be opened from the outside when the child protection locks are engaged.
- In hot weather, the temperature inside the vehicle can rise very quickly after the engine is turned off. Do not leave animals or children inside parked vehicles in hot weather; interior heat buildup may cause serious injury or death. If even left there for a short time, it is likely that serious injury or death could occur.

NOTE: For emergency exit with the system engaged, move the lock switch up to the unlocked position, roll down the window, and open the door with the outside door handle.

Power Windows**Power Window Switches**

The driver's door trim panel has switches that operate all four power windows. There are single window controls on each passenger door trim panel that operate each respective passenger door window. The windows will operate only when the ignition switch is turned to the ON position and will remain active for 60 seconds after the ignition key is removed.

**Power Window Switches****⚠ WARNING!**

Never leave children in a vehicle with the key in the ignition switch. Occupants, particularly unattended children can become trapped by the windows while operating the power window switches which may result in serious injury or death.

Auto - Down Feature

All four power window switches have the Auto-Down feature. Press and hold the window switch for one second, release, and the window will go down automatically.

NOTE: If any power windows are open while pressing the LOCK button on the key transmitter, the windows will automatically be closed. If the vehicle is equipped with a 2.4L engine, the power windows can be closed using the key transmitter, but you must press and hold the LOCK button until all windows are closed completely.

Rear Window Safety Switch

There is a safety switch on the driver door trim panel. Press the switch to lock all passenger side power windows. Cancel this feature by pressing the switch again. This feature is recommended if there are children in your vehicle.

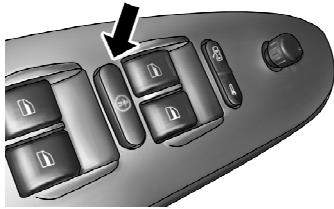

beom020008

Rear Window Safety Switch

⚠ WARNING!

There is no anti-pinch protection when the window is closing. To avoid personal injury, be sure to clear all arms, hands, fingers and all objects away from the window path before closing.

Occupant Restraints

Lap/Shoulder Belts

Be sure everyone in your vehicle is in a seat and properly using a seat belt. Never use a lap/shoulder belt or lap belt for more than one person. Make sure that the seat belt is properly fastened without looseness, twists, or obstruction.

⚠ WARNING!

A lap belt worn too high can increase the risk of internal injury in a collision. The belt forces won't be at the strong hip and pelvic bones, but across your abdomen. Always wear the lap belt as low and snug as possible.

In a collision, an unrestrained child, even a tiny baby, can be propelled inside the vehicle if not properly restrained. The force required to hold even an infant on your lap could become so great that you could not hold

the child, no matter how strong you are. The child and others can be badly injured. Any child riding in the vehicle should be in an appropriate restraint for the child's size.

Lap/Shoulder Belt Warning Light



With the ignition switch ON, this light is illuminated. It will not turn off until the driver properly attaches the

seat belt.

Lap/Shoulder Belt Operating Instructions

The seat belt latch plate is above the back of the front seat, next to your shoulder. Grasp the latch plate and pull out the belt. While pulling out the belt, slide the latch plate up the webbing as far as necessary to allow the belt to go around your lap. When the belt is long enough to fit, insert the latch plate into the buckle until you hear a "click".

⚠ WARNING!

A belt that is fastened into the wrong buckle will not protect you properly. Always buckle your belt into the nearest buckle.

To release the belt, push the red button on the buckle. The belt will automatically retract to its stowed position. If necessary, slide the latch plate down the webbing to allow the belt to retract fully.

Central Two-Point Seat Belt for Rear Seat

This seat belt length cannot be adjusted automatically. The seat belt is adjusted by an adjustable buckle that slides along its length to provide the proper fit for the passenger. When the belt has been adjusted to fit the passenger, insert the latch plate into the buckle until you hear a "click", and then adjust the length of seat belt manually across your abdomen.

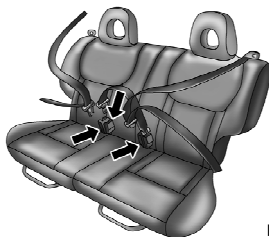

Item020005

Rear Central Two-Point Seat Belt**⚠ WARNING!**

A twisted belt cannot perform properly. In a collision, it could even cut into its passenger. Be sure the belt is straight. If you can't straighten a belt in your vehicle, take it to an authorized Chery dealer and have it repaired.

Adjustable Upper Shoulder Belt Anchorage

In the driver's seat and front passenger's seat, the shoulder belt can be adjusted upward or downward to position the belt away from the driver's or passenger's neck. Push and fully de-

press the button to release the anchorage, and move it up or down to the position that fits you best.

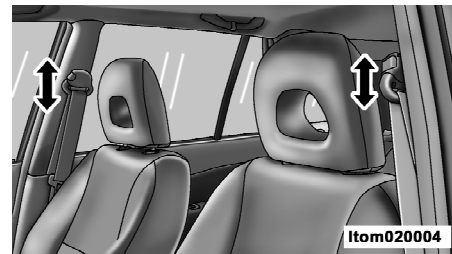

Item020004

Adjustable Upper Shoulder Belt Anchorage**Maintenance for Seat Belt****Inspection Of Seat Belt**

The seat belt should be inspected regularly for damage or frays. Damaged parts must be replaced immediately. Seat belt assemblies must be replaced after a collision if they have been damaged.

⚠ WARNING!

Do not disassemble or modify the seat belt.

Washing Seat Belt

The seat belt should be washed with vehicle detergent or warm water and allowed to dry naturally.

⚠ WARNING!

Never use chemical detergents, boiled water, bleach or dye to wash the seat belt.

Never allow water to enter the belt retractor.

Airbag

The airbags work with the seat belts to properly restrain the driver and front-seat passenger in the event of a collision.

NOTE: As the triggered airbags deflate you may see some smoke-like particles. The particles are a normal by-product of the process that generates the nontoxic gas used for airbag inflation.

The front occupants must be sitting as upright as possible in order to be effectively protected.

⚠ WARNING!

Always properly position your seat belt to maintain the proper distance from the steering wheel. Only then can the airbag provide optimal protection during a collision.

Front Airbags**Front Airbags**

The seat and backrest must be positioned correctly for the airbag to provide optimal protection during a collision. The vertical sitting posture is best when the lower back is in contact with the seat backrest as much as possible and the inclination of seat backrest is not over 30 degrees. Never position the front seat too close to the instrument panel. While driving, the steering wheel should be held with the arms slightly flexed. This is an ideal driving posture, which helps to decrease the risk of the driver being

injured in a collision in which the airbag does not deploy.

The front airbag will deploy in a moderate to severe frontal collision or within the scope of left/right 30 degrees collisions. When it touches the occupant, it instantly deflates to cushion the forward movement of the occupant. An airbag is designed to deploy in moderate to severe frontal or near-frontal crash. The airbag will deploy only if the impact speed is above the system's designated threshold level.

WARNING!

Do not put anything on or around the front airbag covers or attempt to manually open them. Take your vehicle to an authorized Chery dealer for steering wheel, steering column and airbag system service or you could be injured because of accidental airbag deployment.

Airbag Warning Light

When the ignition switch is in ON, the warning light in the instrument panel will be turned on and remain on for 3-4 seconds. If the light does not come on, remains illuminated after you start the vehicle, or if it comes on as you drive, take your vehicle to an authorized Chery dealer for inspection. It is suggested by the airbag manufacturer that the airbag should be replaced after 10 years of service because the efficiencies of the inflating agent and airbag deteriorate. If you are not clear about the service life of your vehicle's airbag, your authorized Chery dealer can answer any questions or address any concerns you may have. Take your vehicle only to an authorized Chery dealer for service.

Child Restraint

Please follow the manufacturer's directions exactly when installing an infant or child restraint.

WARNING!

In a collision, an unrestrained child, even a tiny baby, can become a missile inside the vehicle. The force required to hold even an infant on your lap could become so great that you could not hold the child, no matter how strong you are. The child and others could be badly injured. Any child riding in your vehicle should be in a proper restraint for the child's size.

NEVER use a backward-facing child restraint seat on a passenger seat protected by an airbag. A backward-facing child restraint should only be used in a rear seat. A backward-facing child restraint in the front seat may be struck by a deploying passenger airbag which may cause severe or fatal injury to the infant.

For children under 12 years old or shorter than 150 cm, the special child restraint must be used properly with an infant restraint, child restraint, or with the heightened seat cushion. The child restraint must be applicable and government-authorized. Maximum child safety can be obtained when the safety seat works together with the seat belt.

Children who weigh less than 10 kg or are less than 1 year old should be placed in the baby bed on the rear seat with the baby lying flat and on the bed and restrained. For infants, use the backward-facing child restraint.

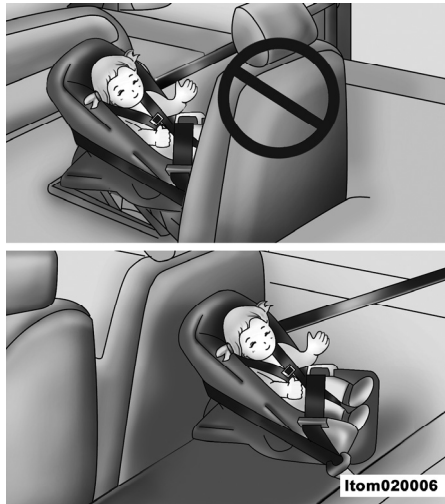

Rearward Facing Child Seat

Children who weigh between 10 kg to 18 kg or are less than 4 years old should use child restraints on the rear seat.



Child Restraint Seat

Children who weigh between 18 kg to 36 kg or are between 4 and 12 years old should sit on the heightened seat cushion on the rear seat. The adjustable auxiliary seat belt fixed on the heightened seat cushion can ensure a child uses the seat belt properly. The heightened seat cushion positions the

belt away from the child's neck and the lap belt should fit across the child's abdomen.

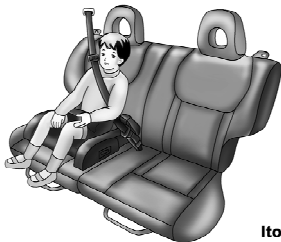

Itom020008

Heightened Seat Cushion

⚠ WARNING!

Each child restraint is intended for one child only.

According to local traffic laws, children are forbidden to sit in the front seat and should use the applicable child restraints.

Operating Safety Tips

Transporting Passengers

NEVER TRANSPORT PASSENGERS IN THE CARGO AREA.

⚠ WARNING!

It is extremely dangerous to ride in a cargo area, inside or outside of a vehicle. In a collision, people riding in these areas are more likely to be seriously injured or killed.

Do not allow people to ride in any area of your vehicle that is not equipped with seats and seat belts.

Be sure everyone in your vehicle is in a seat and using a seat belt properly.

Locking Your Vehicle

Always remove the key from the ignition switch and lock all doors when leaving the vehicle unattended, even in your own driveway or garage. Try to

park your vehicle in a well-lit area and avoid leaving articles of value exposed.

Exhaust Gas

⚠ WARNING!

Exhaust gases can injure or kill. They contain carbon monoxide (CO), which is colorless and odorless. Breathing it can make you unconscious and can eventually poison you and lead to death.

Do not run the engine in a closed garage or in confined areas any longer than needed to move your vehicle in or out of the area.

If it is necessary to sit in a parked vehicle with the engine running, adjust your heating or cooling controls to force outside air into the vehicle. Set the blower at high speed.

If you are required to drive with the back door open, make sure that all windows are closed and the climate control BLOWER switch is set at high speed. DO NOT use the recirculation mode.

The best protection against carbon monoxide entry into the vehicle passenger compartment is a properly maintained engine exhaust system.

Interior Vehicle Safety Inspection

Seat Belts

Inspect the belt system periodically, checking for cuts, frays, and loose parts. Damaged parts must be replaced immediately. Do not disassemble or modify the system.

Front seat belt assemblies must be replaced after a collision. Rear seat belt assemblies must be replaced after a collision if they have been damaged (i.e., bent retractor, torn webbing,

etc.). If there is any question regarding belt or retractor condition, replace the belt.

Airbag Warning Light

The light should come on and remain on for 3-4 seconds as a bulb check when the ignition switch is first turned ON. If the light is not lit during starting, see your authorized Chery dealer. If the light stays on, flickers, or comes on while driving, have the system checked by an authorized Chery dealer.

Defroster

Check the operation by selecting the defrost mode and place the blower control on high speed. You should be able to feel the air directed against the windshield. See your authorized Chery dealer for service if your defroster is inoperable.

Exterior Vehicle Safety Inspection

Tires

Examine tires for excessive tread wear and uneven wear patterns. Check the tires for the following:

- Stones, nails, glass, or other objects lodged in the tread
- Tread and sidewall for cuts and cracks
- Proper pressure (including spare)
- Wheel nuts for proper torque

Lights

Have an assistant observe the operation of exterior lights while you work the controls. Check turn signal and high beam indicator lights on the instrument panel. Check the following lights for proper operation:

- Low beam headlights
- High beam headlights
- Turn signals

- Tail Lamps
- Stop Lights

Fluid Leaks

Check the area under the vehicle after overnight parking. If a leak is suspected, the cause should be located and corrected immediately. Check the following for possible leaks:

- Fuel
- Engine coolant
- Engine oil
- Power steering fluid
- Brake fluid

New Vehicle Break-In Recommendations

Engine Break-In Recommendations

Vehicle frictional resistance is much greater when the vehicle is new. The result of proper engine break-in will impact the service life, operating reliability and vehicle economical efficiency. The following is the proper engine break-in procedure:

During first 1,000 km of operation:

- Do not allow the engine speed to exceed 3,000 rpm
- Do not exceed 100 km/h
- Do not operate the engine at maximum speed when upshifting

During 1,000-1,500 km of operation:

- Driving speed can be gradually increased to greater than 100 km/h
- Engine speed can be gradually increased to its maximum

Safety Tips During Engine Break-In

The maximum engine speed is 6,000 rpm. If the vehicle is equipped with a manual transmission, the vehicle must be shifted into the next highest gear before the needle of tachometer is in the red range.

NOTE: To utilize your vehicle efficiently, avoid operating the engine at unnecessary high speeds. To optimize fuel efficiency, the vehicle should be shifted to the next highest gear position at the proper engine/road speed. This will decrease operational noise and help reduce environmental pollution.

NOTE: The engine is also at risk if it is operated at too low an engine speed. It should be shifted to a lower gear position in order to maintain the proper engine speed.

NOTE: The engine must be at normal operating temperature before operating the engine at high speed.

Braking System Break-In Recommendations

The brakes cannot provide the ideal friction to stop during the vehicle's first 200 km of operation. You should depress the brake pedal firmly to increase friction and improve stopping capability.

Tire and Wheel Break-In Recommendations

New tires require a brief break-in period. Your vehicle should be driven slowly and especially carefully within the first 100 km of driving.

Vehicle wheel nuts must be re-tightened to the specified torque after the first 800 km of driving. Also, when a wheel has been replaced or after wheel nuts have been loosened, they must be re-tightened to the specified torque after driving 800 km.

FEATURES OF YOUR VEHICLE

CONTENTS

► Mirrors	35	► Seats	39	▷ Rear Fog Lights	44
▷ Inside Rearview Mirror	35	▷ Manual Front Seat Adjustments	39	▷ Turn Signals	44
▷ Outside Mirror	35	▷ Manual Rear Seat Adjustments	40	▷ Dimmer Control	45
▷ Outside Mirrors Folding Feature	35	▷ Head Restraints	42	▷ Headlight Leveling System	45
▷ Power Remote Control Mirrors	35	▷ Heated Seats (If Equipped)	42	▷ Front Interior Lighting	45
▷ Heated Remote Control Mirrors	36	► Lights	43	▷ Rear Interior Lighting	45
▷ Vanity Mirrors	36	▷ Headlights, Parking Lights (Front Position Lights, Instrument Panel Lights and License Light)	43	▷ Keyhole Light	46
► Windshield Wipers and Washers	36	▷ High Beam/Low Beam Select Switch	43	▷ Brake Lights	46
▷ Front Windshield Wipers and Washers	37	▷ Flash to Pass	44	▷ Reverse Lights	46
▷ Rear Window Wiper and Washer	38	▷ Front Fog Lights (If Equipped)	44	► Electrical Power Outlet	46
				► Cruise Control	47
				▷ Cruise Control (If Equipped)	47
				▷ To Activate	47
				▷ To Set A Desired Speed	47
				▷ To Deactivate	48

34 – FEATURES OF YOUR VEHICLE

▷ To Vary The Set Speed	48	▷ Tilt Down Feature	49	▷ Rear Cupholder	51
▷ To Accelerate for Passing	48	▷ Sunshade Operation	50	▶ Storage Areas	52
▷ To Resume Set Speed	48	▶ Cigarette Lighter and Ashtray	50	▷ Center Console	52
▶ Sunroof (If Equipped)	49	▷ Cigarette Lighter	50	▷ Overhead Console	52
▷ Opening Sunroof	49	▷ Front Ashtray	50	▷ Glove Box	52
▷ Closing Sunroof	49	▷ Rear Ashtray	51	▷ Auxiliary Storage Compartments	53
▷ Anti-Pinch Feature	49	▶ Cup and Bottle Holders	51	▷ Cargo Area	53
▷ Anti-Pinch Override	49	▷ Front Cupholder	51	▷ Roof Luggage Rack	55
▷ Tilt UP Feature	49				

Mirrors

Inside Rearview Mirror

Adjust the mirror to a center view position through the rear window. Night time headlight glare can be reduced by moving the control lever under the mirror to the night position.

NOTE: The mirror viewing range should be adjusted in the day position before using the night position.

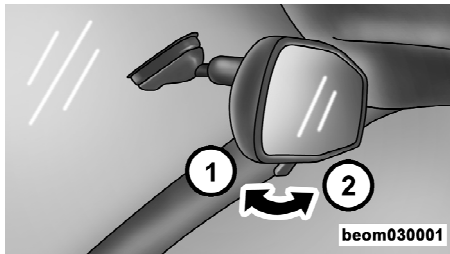

Inside Rearview Mirror

1 - Day

2 - Night

Outside Mirror

For the driver's maximum benefit, adjust the outside mirrors to center on the adjacent lane of traffic, slightly overlapping the view obtained from the inside mirror.

WARNING!

Vehicles and other objects seen in the outside mirrors will appear smaller and farther away than they really are. Relying solely on your door mirrors could cause you to collide with another vehicle or object.

Outside Mirrors Folding Feature

Outside mirrors can be folded manually. The outside mirror can be restored to its normal position by unfolding it outward to the proper position.

Power Remote Control Mirrors

The power mirror switch is located on the driver's door trim. A rotary knob selects the left mirror, right mirror, or off position.



Power Mirror Adjust Switch

Outside mirrors can be adjusted remotely on the driver's door trim panel only when the ignition switch is in the ON position. After selecting a mirror,

toggle the knob in the same direction you want the mirror to move. When finished, return the knob to the center middle position to guard against accidental mirror movement.

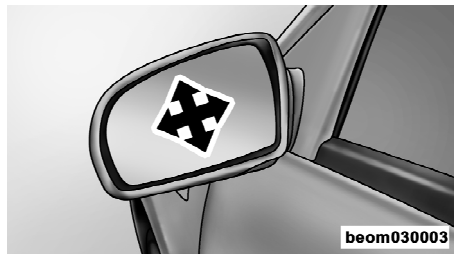

Mirror Directions

Heated Remote Control Mirrors

The outside mirrors are heated to melt frost or ice. This feature is activated whenever the rear window defogger is activated. Refer to "Rear Window Defroster" in Chapter 5 of this manual for more information.

Vanity Mirrors

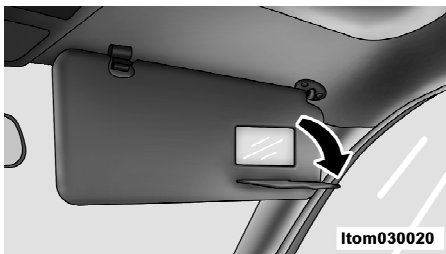

Vanity Mirror

Vanity mirrors are equipped on both driver side and passenger side sun visors. To use the vanity mirrors, rotate the sun visor down and swing the mirror cover downward.

Windshield Wipers and Washers

The wiper and washer control lever is located on the right side of the steering column. The wiper/washer operates only when the ignition switch is in the ON position.

CAUTION!

In cold weather, always turn the wiper switch OFF and allow the wipers to return to the park position before shutting off the engine. If the wiper switch is left ON and the wipers freeze to the windshield, damage to the wiper motor may occur when the vehicle is restarted.

Always remove any buildup of snow that prevents the windshield wiper blades from returning to the park position. If the windshield wipers are operated before the snow is removed, damage to the wiper motor may occur.

Never operate the windshield wipers when the windshield is dry. Operating the windshield wipers on a dry windshield will scuff the windshield and permanently damage the wiper blades.

Front Windshield Wipers and Washers

High and Low Speed Feature

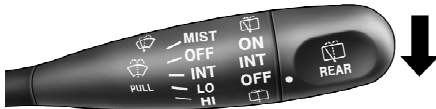

Item030001

High and Low Speed Control

Move the lever down to the first setting past the intermittent settings for low speed wiper operation, or to the second setting past the intermittent settings for high speed wiper operation.

Mist Feature



Item030007

Mist Control

Move the lever to the MIST position to activate a single wipe cycle to clear the windshield. The wiper will continue to operate until you release the lever.

Intermittent Wiper Feature

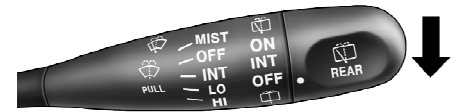

Item030001

Front Wiper Intermittent Control

Move the lever down to the INT position to make a single wiping cycle with a pause between cycles.

Windshield Washer Feature



Item030008

Windshield Washer Control

To activate the washer, pull the Windshield Wiper/Washer Control lever toward you and hold it for as long as washer spray is desired. If you activate the washer while the wiper control is in the OFF position, the wipers will operate for three wipe cycles then turn OFF.

CAUTION!

The windshield washer operating time should be no longer than 10 seconds.

(Continued)

CAUTION! (Continued)

Operating the windshield washer when the fluid tank is empty may damage the washer motor.

Rear Window Wiper and Washer Normal Speed Feature



Item030009

Rear Wiper Normal Speed Control

Rotate the end of the wiper switch lever to the ON position for normal rear wiper speed operation.

Intermittent Wiper Feature



Item030049

Rear Wiper Intermittent Control

Rotate the end of the wiper switch lever to the INT position to make a single wiping cycle with a pause between cycles.

Rear Window Washer Feature



Item030010

Rear Window Washer Control

To activate the rear washer, rotate the end of the wiper switch lever downward to the last setting past the OFF position and hold it for as long as washer spray is desired.

CAUTION!

The rear washer operating time should be no longer than 10 seconds.

Operating the rear washer when the fluid tank is empty may damage the washer motor.

Seats

Manual Front Seat Adjustments

Forward and Rearward Adjustment

The manual seat adjustment bar is at the front of the seat, near the floor. Pull the bar upward and slide the seat forward or backward. Release the bar once the seat is in the desired position. To confirm the seat is locked into

place, attempt to move the seat forward and backward after adjusting the seat.

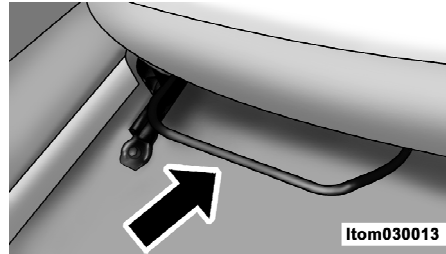

Manual Seat Adjustment

WARNING!

Never adjust the seat while driving. The sudden movement of the seat could cause you to lose control. Adjust the seat only while the vehicle is parked.

Recliner Adjustment

The recliner control lever is on the outboard side of the seat. To recline the seat, lean forward slightly before lifting the lever, then lean back to the desired position and release the lever. Lean forward and lift the lever to return the seat back to its normal position.

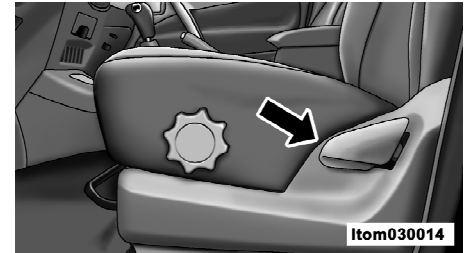

Seat back Recliner Lever

Manual Seat Bottom Cushion Adjustment

The inclined height of driver's seat cushion can be adjusted by using the knob on the outboard side of the seat. To confirm the seat cushion is locked

into place, attempt to move the seat cushion after adjusting.

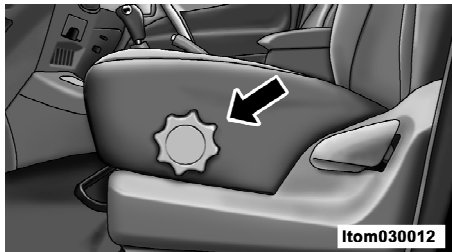

Seat Bottom Cushion Adjustment Knob Manual Rear Seat Adjustments

Forward and Rearward Adjustment

The manual seat adjustment bar is at the front of the rear seats, near the floor. Pull the bar upward and slide the seat forward or backward. Release the bar once the seat is in the desired position. To confirm the seat is locked into place, attempt to move the seat forward and backward after adjusting the seat.

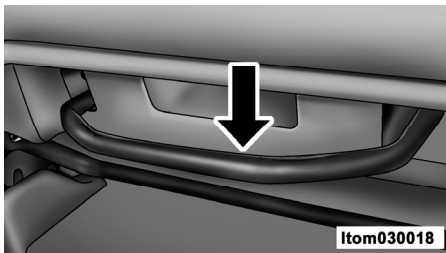

Manual Rear Seat Adjustment Folding Rear Seats

To provide additional storage area, each rear seat back can be folded forward. Pull the strap forward to move the seat forward and flat.

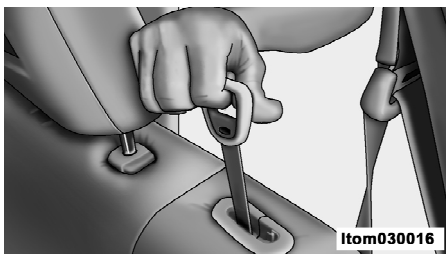

Folding Rear Seats

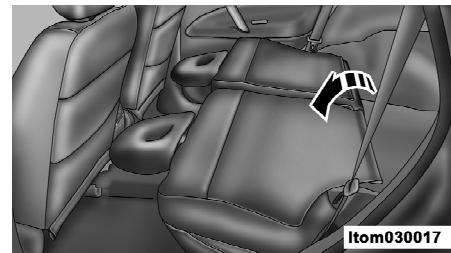

Rear Seats Folded Flat

NOTE: Prior to folding the rear seats, be sure that the front seats are fully upright and positioned forward. This will allow the rear seat to fold down easily.

Removing Rear Seats

To provide additional storage area, the rear seats can be removed. Perform the following procedure to remove the rear seats.

- Fold the seat back down, and press the rear seat release lever.

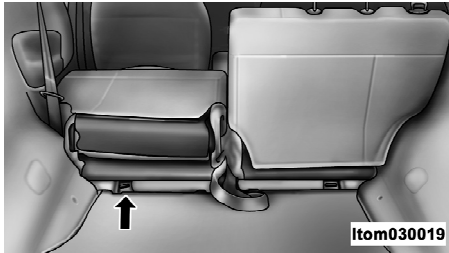

Rear Seat Release Lever

- Slowly pivot the entire seat forward.



Pivoting Rear Seat

- Release the seat and pull the seat out and away from the lower bracket.

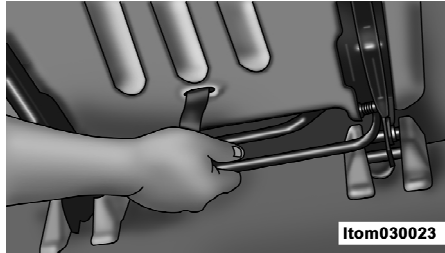

Releasing Rear Seat

- Remove the seat from the vehicle.



Removing Rear Seat

Installing Rear Seat

Install the seats in the reverse order of removal.

⚠ WARNING!

- It is extremely dangerous to ride in a cargo area, inside or outside of a vehicle. In a collision, people riding in these areas are more likely to be seriously injured or killed.
- Do not allow people to ride in any area of your vehicle that is not equipped with seats and seat belts.
- Be sure everyone in your vehicle is in a seat and using a seat belt properly.
- In a collision, you or others in your vehicle could be injured if seats are not properly latched to their floor attachments. Always be sure that seats are fully latched.

Reclining Rear Seat

For additional comfort, pull the seat strap forward just enough to release the seat back latch. Then, push the seat back to the desired reclined position, and release the strap.



Reclining Rear Seat

Head Restraints

Head restraints can reduce the risk of whiplash injury in an accident. Head restraints can only protect the occupant if they are adjusted properly.

Front Head Restraints

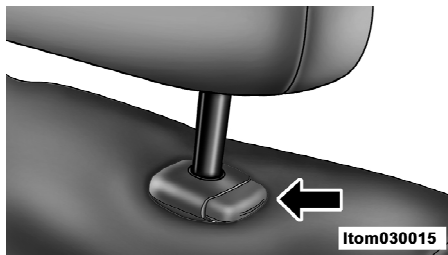

Head Restraint Adjustment

Adjusting the Head Restraints

Press the lock release button, then pull up on the head restraint to raise and push down to lower.

Removing or Installing the Head Restraints

To remove the head restraint, you must simultaneously press the lock release button and pull out the head restraint. To reinstall the head restraint, insert the posts into the sleeves and push the head restraint downward until it locks into place.

Rear Head Restraints

The adjustment of rear head restraints is the same as the front head restraints.

⚠ WARNING!

Never sit in a seat or allow a passenger to sit in a seat without having the head restraint in place and adjusted properly as it may result in personal injury to you or your passenger in an accident.

Heated Seats (If Equipped)

Heated seats provide comfort and warmth in cold weather. The heaters provide the same heat level for both the seat cushion and back. The driver seat and front passenger seat are heated.

The controls for each seat heater are located near the bottom center of the instrument panel. After turning the ignition ON, you can choose from High or Low heat settings. When the switch is in the middle position, the seat heater is Off. Each switch is equipped with LED lights to indicate the level of heat that each seat is set at.

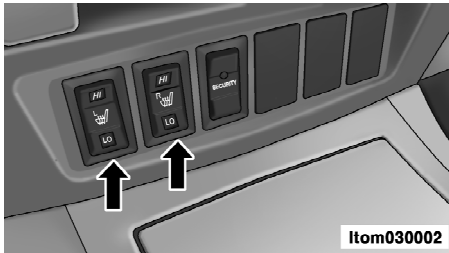

Item030002

Heated Seat Switches

Lights

Headlights, Parking Lights (Front Position Lights, Instrument Panel Lights and License Light)

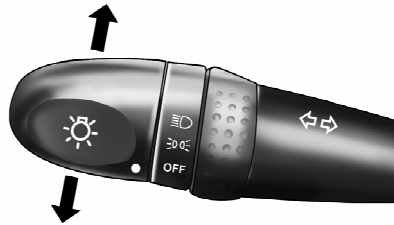

Item030025

Headlight Control

Turn the end of the multifunction switch lever to the first setting for parking lights (front position lights, instrument panel lights and license light). Turn the end of the lever to the second setting for headlight operation.

NOTE: The headlights only work when the ignition switch is ON. The headlights

will turn off automatically when the engine is starting or when the engine is stopped.

High Beam/Low Beam Select Switch



Item030026

High Beam Control

When the multifunction lever is in the headlight position, push the multifunction lever away from you to switch the headlights to the HIGH beam position. When the high beam position is selected, the high beam indicator on the instrument cluster will illuminate immediately. Pull the lever toward you to switch the headlights back to LOW beam.

Flash to Pass

While driving, you can signal another vehicle with your headlights by lightly pulling the multifunction lever toward you. This will cause the headlights to switch from low beam operation to high beam operation and remain on until the lever is released. Repeating this operation can flash the high beam headlights continuously.

Front Fog Lights (If Equipped)



Front Fog Light Switch

The front fog light switch is located at the lower left of the instrument panel. With the multifunction switch in the first or second lighting position, press

the front fog light switch to turn on the front fog lights. When the front fog lights are ON, the indicator on the instrument cluster illuminates immediately. The front fog light should only be used in foggy, snowy, or rainy conditions.

Rear Fog Lights

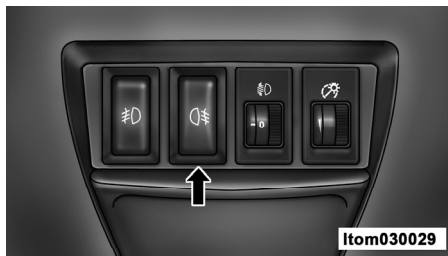

Rear Fog Light Switch

The rear fog light switch is located at the lower left of the instrument panel. With the multifunction switch in the second lighting position or when the front fog lights are turned on first, press the rear fog light switch to turn on the rear fog lights. When the rear

fog lights are ON, the indicator on the instrument cluster illuminates immediately. The rear fog lights may distract or affect visibility of drivers behind you. Operating this light is recommended only under the lowest visibility conditions.

Turn Signals



Turn Signal Control

Move the multifunction lever upward or downward and the corresponding turn signal indicator on the instrument panel will flash. Turn signals operate only when the ignition switch is in the ON position.

Dimmer Control

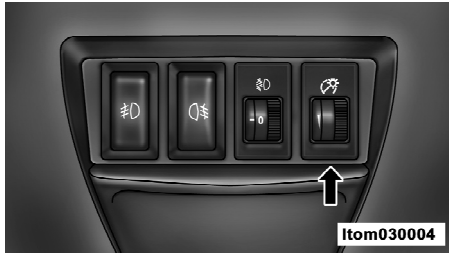

Dimmer Control Switch

The Dimmer Control is located at the lower left of the instrument panel. It controls the brightness of the instrument panel lights.

Headlight Leveling System



Headlight Leveling Switch

The headlight leveling switch is located at the lower left of the instrument panel. It can be operated in four positions: 0, 1, 2, or 3. Each setting can be used to adjust the headlight level as required under specific driving conditions.

Front Interior Lighting

The front interior light is located in the headliner above the rearview mirror.

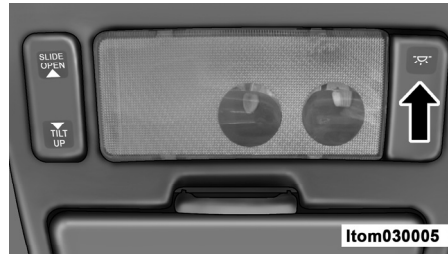

Front Interior Light Switch

The front interior light is activated ON by pressing the switch once. Press the switch a second time to turn the light OFF.

Rear Interior Lighting

The rear interior light is located in the headliner, in the rear seat area.

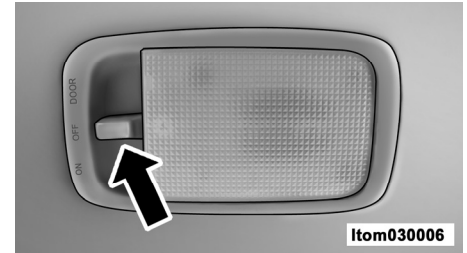

Rear Interior Light Switch

The light can be activated ON for continuous illumination by sliding the switch to the ON position. When the switch is in the DOOR position, opening any door will turn on the interior light. When the door is closed, the interior light will remain illuminated for 8 seconds. This delay feature is deactivated when the ignition switch is in the ON position.

NOTE: When the ignition key is removed, and the door is opened, the rear interior light will remain illuminated for 15 minutes or until the door is closed.

Keyhole Light

The keyhole light encircles the ignition keyhole. The light illuminates when you open the driver side door. The light will remain on for 6 seconds. The light turns OFF when the ignition switch is turned to the ON position.

Brake Lights

Depressing the brake pedal will illuminate the brake lights, and releasing the brake pedal will turn the brake lights off.

Reverse Lights

With the ignition switch in the ON position, the reverse lights illuminate when the transaxle is placed in the reverse range. The lights turn OFF when the ignition switch is in the LOCK position, or the transaxle is shifted into another range.

Electrical Power Outlet

There is a 12 Volt electrical outlet located on the right trim panel below the center console. This outlet is powered directly from the battery. Power is available at all times, regardless if the ignition is ON or OFF.

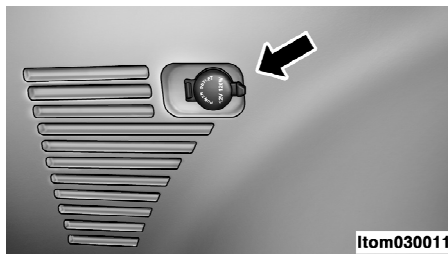

12 Volt (120W) Power Outlet

CAUTION!

- **Accessories, even when not in use (i.e. cellular phone, etc.) will draw power from the vehicle's battery. Eventually, if accessories are plugged in long enough, the vehicle's battery will discharge and degrade the battery life and/or prevent engine starting.**
- **Accessories that draw excessive power (i.e. coolers, vacuum cleaners, lights, etc.) will quickly drain the battery. Only use these intermittently and with caution.**
- **After the use of high power drawing accessories, or long periods of time without starting the vehicle (with accessories still plugged in), the vehicle must be driven a sufficient length of time to allow the generator to recharge the vehicle's battery.**

(Continued)

CAUTION! (Continued)

- This power outlet is designed for 12 Volt (120W) use only. Do not use any type of accessory above this voltage.

Cruise Control**Cruise Control (If Equipped)**

When engaged, the cruise control system takes over the accelerator operation at speeds between 25 km/h and 130 km/h. The cruise control switches are located on the steering wheel.

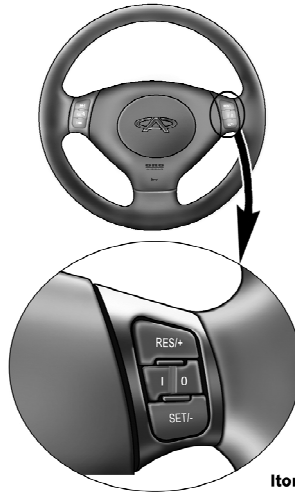

Item040005

Cruise Control Switch Location To Activate



To turn the cruise control system ON, push the "I" side of the I/O switch. The CRUISE indicator in the instrument cluster will flash when the system is ON. After you set the cruise

control to the desired speed, the CRUISE indicator will then illuminate steady. To turn the system OFF, push the "O" side of the I/O switch. The CRUISE indicator will then turn off. The system should be turned OFF when not in use.

WARNING!

Leaving the cruise control system ON when not in use is dangerous. You could accidentally activate the system, or cause the vehicle to go faster than you want. You could lose control and have an accident. Always leave the system OFF when not in use.

To Set A Desired Speed

When the vehicle has reached the desired speed (between 25 km/h - 130 km/h), press the "SET" switch, release the accelerator and the vehicle will operate at the selected speed.

NOTE: The vehicle should be traveling at a steady speed and on a level road before pressing the "SET" switch.

To Deactivate

To turn the cruise control system OFF, press the "O" switch or apply the vehicle brake to deactivate the cruise control. Pressing the "O" switch or turning off the ignition switch erases the set speed memory, but pressing the brake will not erase set speed memory.

To Vary The Set Speed

To Accelerate:

When the cruise control is ON, tapping the "+" side of the "RES/+" switch once will result in a 2 km/h speed increase. If you press the "+" switch and hold it, the vehicle speed will increase continually until you release it.

To Decelerate:

When the cruise control is ON, tapping the "-" side of the "SET/-" switch once will result in a 2 km/h speed decrease. If you press the "-" switch and hold it, the vehicle speed will decrease continually. Release the switch when the desired speed is reached, and the new speed will be set.

NOTE: It is not recommended to press and hold the "+" switch for an extended time. An accident may occur.

To Accelerate for Passing

Depress the accelerator as you would normally and accelerate to complete the pass. When the pass is complete, release the accelerator and allow the vehicle to return to the prior set speed.

To Resume Set Speed

If you deactivate the cruise control without erasing the set speed from memory, you can resume the set speed by pressing the "RES" side of the "RES/+" switch and release. Resume can be used at any speed above 25 km/h.

WARNING!

Cruise control can be dangerous where the system can't maintain a constant speed. Your vehicle could go too fast for the conditions, and you could lose control. An accident could be the result. Do not use cruise control in heavy traffic or on roads that are winding, icy, snow-covered, or slippery.

Sunroof (If Equipped)

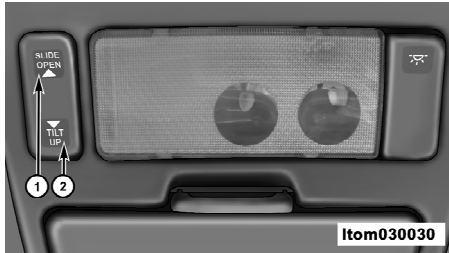

Sunroof Switch

1 - SLIDE OPEN 2 - TILT UP

Opening Sunroof

Press and momentarily hold the SLIDE OPEN (1) switch and release. The sunroof will open fully and then stop automatically.

NOTE: During this operation, any movement of the sunroof switch will stop the sunroof.

Closing Sunroof

Press and momentarily hold the TILT UP (2) switch and release. The sunroof will close fully and stop automatically.

NOTE: During this operation, any movement of the sunroof switch will stop the sunroof.

Anti-Pinch Feature

This feature will detect an obstruction in the sunroof's path while closing. If an obstruction is detected, the sunroof will automatically retract. If this occurs, remove the obstruction, then press the TILT UP switch and release to close.

Anti-Pinch Override

If the sunroof retracts more than three times continuously, the sunroof's auto-closing feature will be lost. The anti-pinch feature and auto-closing features can be restored only by pressing and holding the TILT UP switch until the sunroof is closed completely.

NOTE: The anti-pinch feature is disabled while the TILT UP switch has been pressing and holding.

⚠️ WARNING!

There is no anti-pinch protection when the sunroof is almost closed. To avoid personal injury, be sure to clear your arms, hands, fingers and all objects from the sunroof path before closing.

Tilt UP Feature

With the sunroof closed, press and momentarily hold the TILT UP (2) switch and the end of the sunroof glass will tilt up automatically. During this operation, any movement of the sunroof switch will stop the sunroof.

Tilt Down Feature

Press and momentarily hold the TILT UP (2) switch and the end of the sunroof glass will automatically tilt downwards into the closed position.

Sunshade Operation

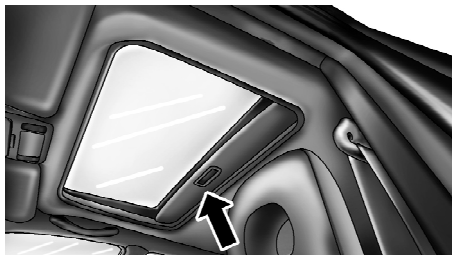

Sunshade Position

The sunshade can be opened manually. However, the sunshade will open automatically as the sunroof opens.

NOTE: The sunshade cannot be closed if the sunroof is open.

Cigarette Lighter and Ashtray

Cigarette Lighter

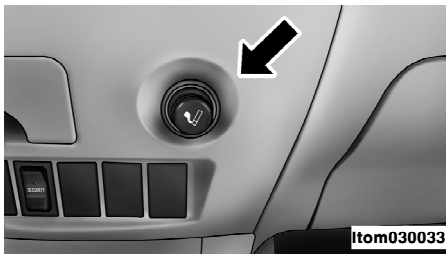

Cigarette Lighter

The cigarette lighter is located in the middle of the instrument panel, under the climate controls. Press the cigarette lighter inward and wait until it automatically pops out. The cigarette lighter can be used when the ignition switch is OFF.

⚠ WARNING!

To prevent injury to passengers and damage to your vehicle, never press and hold the cigarette lighter for an extended period of time. If children are left in the vehicle, the cigarette lighter should be removed.

Front Ashtray

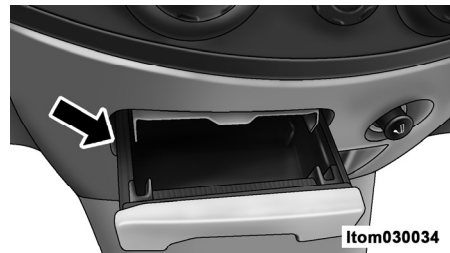

Front Ashtray

The front ashtray is located in the middle of the instrument panel, under the climate controls.

Rear Ashtray

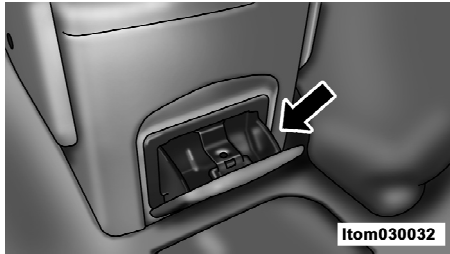

Rear Ashtray

The rear ashtray is located in the back of the center console, behind the armrest.

Cup and Bottle Holders

Front Cupholder

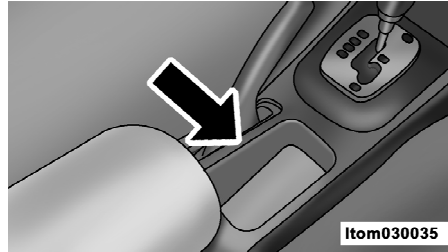

Front Cupholder Location

The front cupholder is located on the center console.

Rear Cupholder

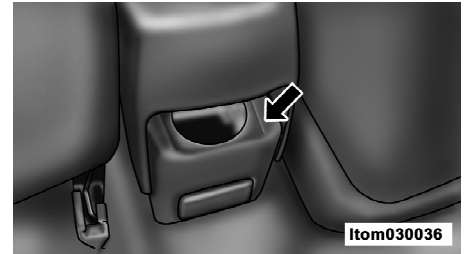

Rear Cupholder Location

The rear cupholder is located in the back of the center console, behind the armrest. Rotate the cupholder cover downward to expose the rear cupholder.

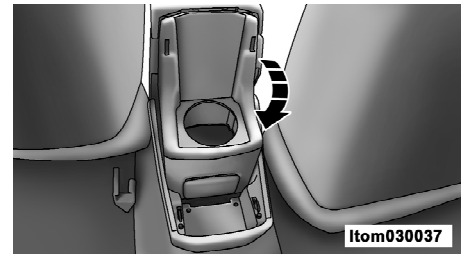

Rotating Rear Cupholder Cover

⚠ WARNING!

If containers of hot liquid are placed in the cup holder, they can spill while transporting them. Use caution when transporting hot liquids to avoid injury.

Storage Areas

Center Console

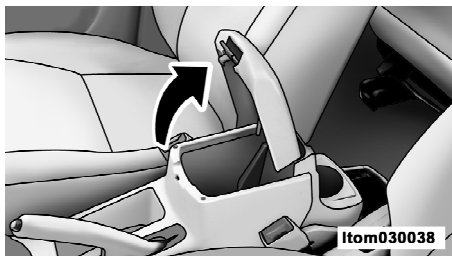

Center Console

Lifting the latch at the front of the hinged armrest provides access to the center console storage area.

Overhead Console



Overhead Console

The Overhead console is located in the headliner above the rearview mirror. Eyeglasses can be stored in the overhead console. To use it, press the latch of the console and rotate it down.

Glove Box

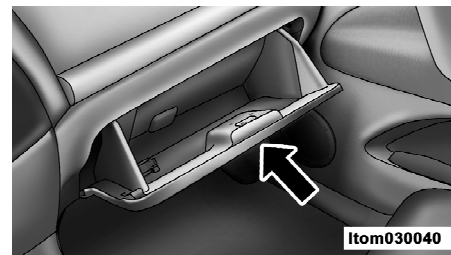

Glove Box

To use the glove box:

- Open the glove box by pulling the release lever.
- Lock the glove box by inserting the key and turning it clockwise.
- Unlock the glove box by inserting the key and turning it counterclockwise.

CAUTION!

To reduce the chance of injury in case of an accident or a sudden stop, always keep the glove box closed while driving.

Auxiliary Storage Compartments

Front Storage Compartment

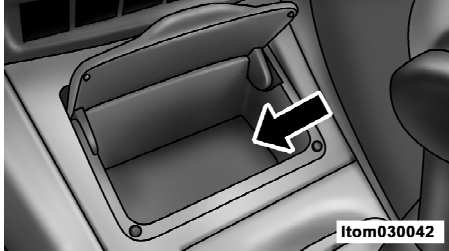

Front Storage Compartment Location

The front storage compartment is located at the bottom of the center console. Pull the cover upward to open the compartment.

Driver's Side Storage Compartment

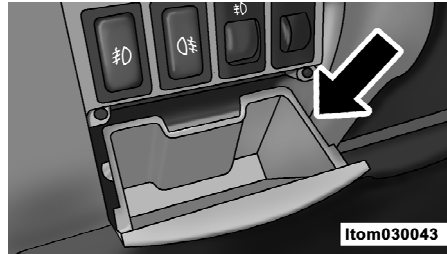

Driver's Side Storage Compartment Location

The driver's side storage compartment is located at the lower left side of the instrument panel. To use this compartment, rotate the storage compartment downward.

Small Storage Compartment

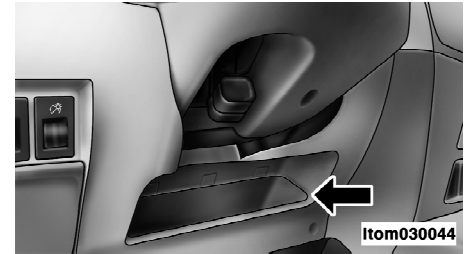

Small Storage Compartment Location

The small storage compartment is located in the lower instrument panel, under the steering wheel.

Cargo Area

Retractable Cargo Area Cover

NOTE: The purpose of this cover is for privacy, not to secure loads. It will not prevent cargo from shifting or protect passengers from loose cargo.

To cover the cargo area:

- Grasp the cover hooks and pull them over the cargo area.

- Connect the hooks to the posts of the rear seat head restraints.

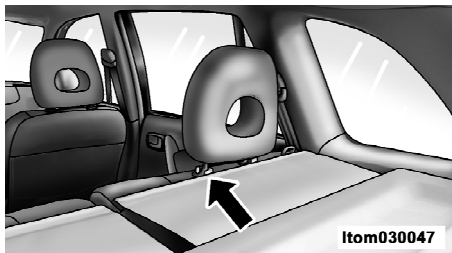

Retractable Cargo Area Cover

Rear Cargo Shelf Panel

The Rear Cargo Shelf Panel attaches to guides in the rear cargo area. The rear shelf panel can be installed in two different positions.

NOTE: The back door can be opened or closed with the rear cargo shelf panel in either position.

⚠ WARNING!

To avoid tipping, lock the cargo shelf securely in all positions.

Do not drive this vehicle with the back door open.

Failure to follow these warnings could result in serious or fatal injury.

Rear Cargo Shelf Panel - Upper Position

Insert the front outboard corners of the cargo shelf panel into the top hooks of the side panels and press down on the back of the shelf panel to lock it into place.

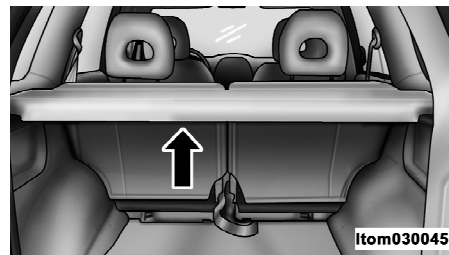

Rear Cargo Shelf Panel - Upper Mounting Position

⚠ WARNING!

Do not load objects on the shelf in the upper mounting position. In an accident, objects could strike occupants, causing serious or fatal injury.

Rear Cargo Shelf Panel - Lower Position

Insert the front outboard corners of the cargo shelf panel into the lower hooks of the side panels and press down on the back of the shelf panel to lock it into place.

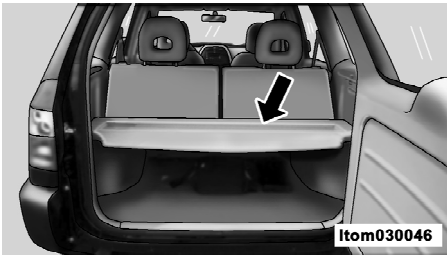

Rear Cargo Shelf Lower Mounting Position

⚠ WARNING!

Do not load heavy objects in the lower mounting position. Failure to follow this warning could cause the shelf to collapse resulting in personal injury.

⚠ WARNING!

In an accident, a loose cargo shelf panel in the vehicle could cause injury. It could fly around in a sudden stop and strike someone in the vehicle.

(Continued)

⚠ WARNING! *(Continued)*

Do not store the cargo cover on the cargo floor or in the passenger compartment. Remove the cover from the vehicle when removed from its mounting. Do not store in the vehicle.

⚠ WARNING!

Always place cargo evenly on the cargo floor. Put heavier objects as low and as far forward as possible.

Place as much cargo as possible in front of the rear axle. Too much weight or improperly placed weight over or behind the rear axle can cause the rear of the vehicle to sway.

Do not pile luggage or cargo higher than the top of the seat back. This could impair visibility or become a dangerous projectile in a sudden stop or collision.

Roof Luggage Rack

The roof rack cross rails and side rails are designed to carry cargo weight. The load must not exceed 68 kg, and it should be distributed uniformly over the cross rails. In addition, the roof rack does not increase the total load carrying capacity of the vehicle. Be sure that the total occupant and luggage load inside the vehicle, plus the load on the roof rack, does not exceed the maximum vehicle load capacity.

Moving the Cross Rails

- Loosen the knob on top of each cross rail to disengage the rail clamp from the side rail.

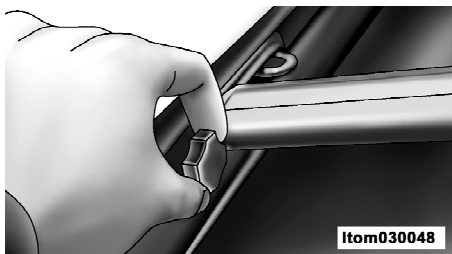

Roof Luggage Rack

- Adjust the cross rails to the desired location.
- Tighten the knobs on each cross rail to lock it in position. As you tighten the knob, make sure the rail clamp engages completely into the side rail slot.
- Confirm that the cross rails are fully locked in position.

CAUTION!

- Cross rails should remain equally spaced or parallel at any luggage rack position. Noncompliance could result in damage to the roof rack, luggage, and vehicle.
- To avoid damage to the roof rack and vehicle, do not exceed the maximum roof rack load capacity of 68 kg. Always distribute loads as evenly as possible and secure the load appropriately.
- The load should be secured and placed on top of the roof rack, not directly on the roof. If it is necessary to place the load on the roof, place a blanket or some other protection between the load and the roof surface.
- Long loads which extend over the windshield, such as wood panels, should be secured to both the front and rear of the vehicle.

(Continued)

CAUTION! (Continued)

- Travel at reduced speeds and turn corners carefully when carrying large or heavy loads on the roof rack. Wind forces, due to natural causes or nearby truck traffic, can add sudden upward loads. This is especially true on large flat loads and may result in damage to the cargo or your vehicle.

WARNING!

Luggage must be securely tied before driving your vehicle. Improperly secured loads can fly off the vehicle, particularly at high speeds, resulting in personal injury or property damage. Follow the Roof Rack Cautions when carrying cargo on your roof rack.

STARTING AND OPERATING YOUR VEHICLE

CONTENTS

▶ Starting and Operating	59	▷ Automatic Transaxle Manual Shift Mode	63	▶ Brake System	65
▷ Preparation Before Starting	59	▷ Shift Lock Feature	64	▷ Parking Brake	65
▷ Normal Starting Procedure	59	▶ Manual Transaxle	64	▷ Dual Circuit Brake System	66
▷ Failed Starting Procedure	60	▷ 5-Speed Manual Transaxle	64	▷ Brake Booster	66
▷ After Starting	60	▷ Shifting	64	▷ Operating Cautions	67
▷ Starting and Operating Cautions	60	▷ Downshifting	65	▶ Antilock Brake System (ABS)	68
▷ Hood Release	61	▶ Four Wheel Drive System (If Equipped)	65	▷ Utilizing ABS Braking	68
▶ Automatic Transaxle (If Equipped)	62	▷ Four Wheel Drive (4WD)	65	▷ ABS Self-Check	68
▷ 4-Speed Automatic Transaxle	62	▷ Driving Off-Highway With 4WD Vehicles	65	▶ Power Steering	68
▷ Gear Ranges	62			▶ Driving Through Water	69
				▶ Driving In Slippery Conditions	70

58 – STARTING AND OPERATING YOUR VEHICLE

▶ Tires	70	▷ Spare Tire	72	▶ Fuel	73
▷ General Information	70	▷ Tread Wear	72	▷ General Information	73
▷ Tire Pressure	71	▷ Replacement Tires	73	▷ Clean Air Gasoline	74
▷ Tire Rotation	72			▷ Adding Fuel	74

Starting and Operating

Preparation Before Starting

Before starting your vehicle, adjust your seat, adjust the inside and outside mirrors, fasten your seat belt, and, if present, instruct all other occupants to buckle their seat belts. Make sure the headlamps and other electrical accessories are OFF.

WARNING!

Never leave children alone in a vehicle. Leaving children in a vehicle unattended is dangerous for a number of reasons. A child or others could be seriously or fatally injured. Do not leave the key in the ignition. A child could operate power windows, other controls, or move the vehicle.

Automatic Transaxle (If Equipped)

Before starting the engine, the transaxle must be in the PARK (P) position.

NOTE: The ignition switch must be in the ON position and you must press the brake pedal before shifting out of PARK (P).

Manual Transaxle (If Equipped)

Before starting the engine, fully engage the parking brake, press the clutch pedal to the floor, and place the gear selector in NEUTRAL.

NOTE: The engine will not start until the clutch pedal is fully depressed.

WARNING!

Racing the engine at high speed may cause excessive heat in the exhaust system, resulting in overheating and vehicle fire, which may cause serious injuries or death.

If there is resistance when turning the ignition switch, try turning the steering wheel left and right until the ignition

switch can be turned ON. This resistance is probably due to any of the following reasons:

- The direction of the front wheels
- The front wheel is touching the curb
- The steering wheel self-locks

Normal Starting Procedure

The following should be performed for normal starts:

- Turn the ignition switch to START without pumping or depressing the accelerator pedal. Release the switch when the engine starts.
- The starter motor may need to remain engaged for up to 15 seconds in very cold conditions until the engine is started.

If the engine fails to start within 15 seconds, turn the ignition switch to the LOCK position, wait 10 to 15

seconds, then repeat the normal starting procedure. If the engine still doesn't start, see "Failed Starting Procedure".

Failed Starting Procedure

The following should be performed if the engine fails to start after two consecutive attempts:

- Press the accelerator pedal to the floor and hold it there.
- Turn the ignition switch to the START position and crank the engine till it starts.
- Once started, release the accelerator pedal slowly as the engine warms up.

CAUTION!

To prevent damage to the starter, do not crank the engine for more than 15 seconds at a time. Wait 10 to 15 seconds before trying again.

After Starting

The idle speed will automatically decrease as the engine warms up.

Self-Adapting Function Of Engine Control System

If the battery cable has been removed from the battery, the vehicle may run irregularly for a short time after the cable is reconnected. This is normal because the engine control system is readapting to the engine.

Limiting Engine Speed

To protect the engine from over-speed, the engine is electronically limited by the Engine Control Module (ECM).

Starting and Operating Cautions

Exhaust Gases

WARNING!

Engine exhaust gas can injure or kill. It contains carbon monoxide (CO) which is colorless and odorless. Breathing it can cause unconsciousness and even death. To avoid breathing CO, follow these safety tips:

- Do not run the engine in a closed garage or confined area any longer than needed before moving your vehicle from the area.
- If it is necessary to sit in a parked vehicle with the engine running in an open area, adjust your heating or cooling controls to force outside air into the vehicle. Set the blower at high speed.

Turn Off Your Engine

Before turning off your engine, always allow the engine to resume normal idling speed and run for several seconds. This assures that the engine's temperature can fall gradually. This is particularly necessary after any period of hard driving.

CAUTION!

The engine's temperature will remain high after you turn the engine off. After the engine is turned off, the vehicle's electric cooling fan will continue to run for approximately 60 seconds. Even if the cooling fan stops, it may run again suddenly because of the high temperature. Therefore, extra attention and caution must be given when working in the engine compartment.

Hood Release

The hood is held closed by primary and secondary latches. Both latches must be released to open the hood.

- Pull the hood release lever located on the lower left side of the instrument panel.

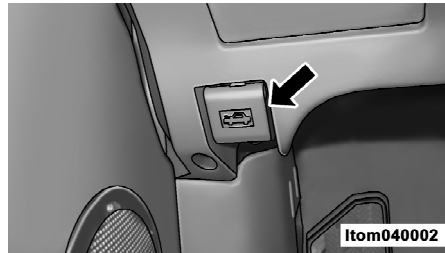

Hood Release Lever

- Pull the secondary latch located through the grille opening, and raise the hood.



Secondary Latch Location

CAUTION!

To prevent possible damage, do not slam the hood to close it. Lower the hood until it is open approximately 20 cm and then drop it. This should secure both latches. Never drive your vehicle unless the hood is fully closed, with both latches engaged.

⚠ WARNING!

If the hood is not fully latched it could fly up when the vehicle is moving and block your forward vision. You could have a collision. Be sure all hood latches are fully latched before driving.

Automatic Transaxle (If Equipped)

4-Speed Automatic Transaxle

The electronically controlled transaxle provides precise shifting. The transaxle electronics are self-calibrating, therefore, the first few shifts on a new vehicle may be somewhat abrupt. This is a normal condition, and precision shifts will develop within a few hundred miles.

Shifting from DRIVE to PARK or REVERSE should be done only after the accelerator pedal is released and the vehicle is stopped. Be sure to keep

your foot on the brake when moving the shift lever between these gears.

Gear Ranges

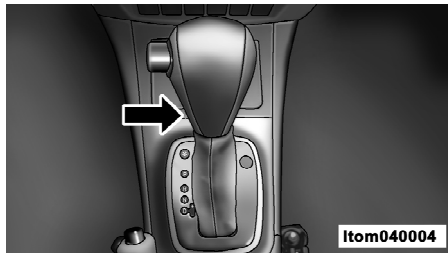

Automatic Shift Lever

PARK (P)

PARK supplements the parking brake by locking the transaxle. The engine can be started in this range. Never attempt to use PARK while vehicle is in motion.

Apply parking brake when leaving vehicle in this range. When parking on a flat surface, place the shift lever in the PARK position first, and then apply the parking brake. When parking on a hill, set the parking brake before plac-

ing the shift lever in PARK. Otherwise, it is difficult to move the shift lever out of PARK because of the load on the transaxle locking mechanism.

REVERSE (R)

This range is used for moving the vehicle backward. Shift into this range only after the vehicle has been stopped completely.

NEUTRAL (N)

The engine may be started in this range.

⚠ WARNING!

Do not coast in NEUTRAL and never turn off the ignition to coast down a hill. These practices are very dangerous and may result in a loss of control of the vehicle or an accident.

DRIVE (D)

This range should be used for normal driving. It provides the smoothest shifting and best fuel economy.

WINTER MODE (W)

Press the "W" switch on the shift panel to accelerate in second gear. This function is used in snowy or icy conditions.

Automatic Transaxle Manual Shift Mode

The automatic transaxle manual shift mode allows you to maximize engine braking, eliminate undesirable upshifts and downshifts, and improve overall vehicle performance. This mode can also provide you with more control while passing, city driving, slippery driving, mountain driving, and many other driving conditions.

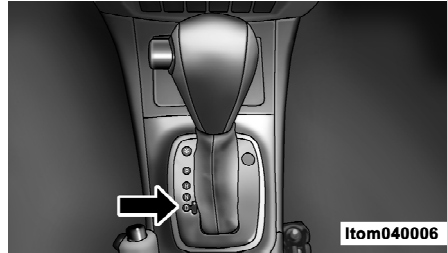
Automatic Transaxle Manual Shift Operation**Manual Shift Mode**

The manual shift mode can be activated only when the shift lever is in the DRIVE (D) range. Move the shift lever to the right side to activate the manual shift mode. Moving the shift lever to the (+) side will upshift the transaxle to the next higher gear. In the same manner, moving the shift lever to the (-) side will downshift the transaxle to the next lower gear. After the manual shift mode is activated, the gear selected is displayed in the

instrument cluster. Moving the shift lever to the (+) or (-) direction will cause an upshift or downshift by one gear.

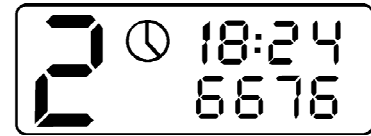
**Item040007****Gear Range Display (2nd Gear Shown)**

NOTE: Downshifts in the manual shift mode are only allowed when the vehicle speed has slowed to the allowable range.

Shift Lock Feature

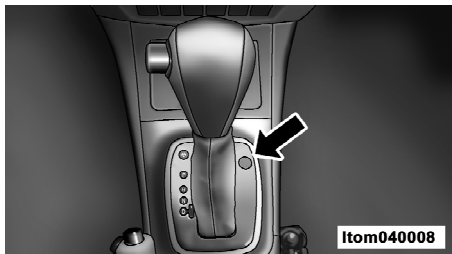

Shift Lock Position

When the ignition switch is in the ON position, push the Shift Lock button on the shifter assembly. With the Shift Lock button activated, you can move the shift lever to different gear selections without pressing the brake pedal.

NOTE: Shift Lock Feature is only be used in the case of an emergency.

Manual Transaxle

5-Speed Manual Transaxle

To utilize your manual transaxle efficiently for both fuel economy and per-

formance, it should be upshifted as effectively as possible.

NOTE: During cold weather, it is normal to experience increased effort in shifting until the transaxle fluid warms up.

CAUTION!

Never drive with your foot resting on the clutch pedal.

Never attempt to hold the vehicle on a hill with the clutch pedal partially engaged.

⚠ WARNING!

You or others could be injured if you leave the vehicle unattended without having the parking brake fully applied.

The parking brake should always be applied when the driver is not in the vehicle, especially on an incline.

Shifting

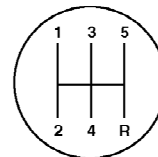

beam040002

5-Speed Shift Pattern

- Always use 1st gear when starting from a standing position.
- Fully depress the clutch pedal before shifting gears. As you release the clutch pedal, lightly depress the accelerator pedal.
- Always use each gear in numerical order, do not skip a gear.
- Apply proper pressure to the shift lever while shifting. Proper pressure reduces the sliding and rubbing time of the synchronizer's lock ring and reduce friction.

- Do not press the shift lever when driving, extra pressure and stress will be placed on the shift fork.
- Shift to reverse gear only when the vehicle is stopped completely.
- Stop and inspect the vehicle if you hear abnormal sounds inside the transaxle.

Downshifting

- When driving down steep hills, downshift to help preserve brakes.
- For better low speed acceleration, downshift when attempting to resume speed.
- To avoid over-speeding the engine and clutch, downshift progressively and do not skip gears.

WARNING!

Do not downshift for additional engine braking on a slippery surface. The drive wheels could lose their traction and the vehicle could skid.

Four Wheel Drive System (If Equipped)

Four Wheel Drive (4WD)

Your vehicle may be equipped with a full-time Four Wheel Drive (4WD) system. With the 4WD option, power will be delivered to the front wheels and distributed to the rear wheels as needed. The 4WD system is active all the time and requires no input from the operator. 4WD uses all four wheels to power the vehicle. This increases traction, enabling you to drive over terrain and road conditions that a conventional two-wheel drive vehicle cannot.

Driving Off-Highway With 4WD Vehicles

Your 4WD vehicle is not intended for off-road use. The 4WD feature gives your vehicle some limited off-road capabilities in which driving surfaces are relatively level, obstruction-free and otherwise similar to normal on-road driving conditions.

NOTE: Operating your vehicle under conditions that could subject the vehicle to excessive stress which might result in damage is not covered under your warranty.

Brake System

Parking Brake

When the parking brake is applied with the ignition ON, the Brake Light in the instrument cluster will illuminate.

⚠ WARNING!

Always apply the parking brake fully when leaving your vehicle or it may roll and cause damage or injury. Also, be certain to leave an automatic transaxle in PARK or a manual transaxle in REVERSE or 1st gear. Failure to do so may allow the vehicle to roll and cause damage or injury.

Be sure the parking brake is fully disengaged before driving, failure to do so can lead to brake problems due to excessive heating of the rear brakes.

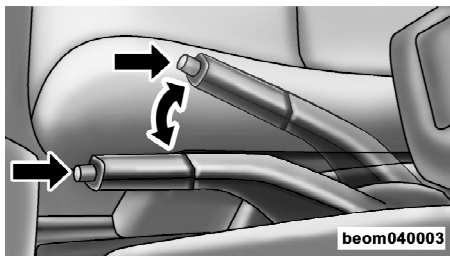

Parking Brake Lever

To apply the parking brake, lift up on the parking brake lever until the resistance is moderate to high (about 7 clicks). Before leaving the vehicle, make sure that the parking brake is fully applied and the gear selector is in the PARK position.

To release the parking brake, slightly pull up the parking brake lever while pushing the release button on the end of the lever. Guide the lever downward to its stop. The brake warning light in the instrument cluster should go out.

NOTE: You should always apply the parking brake before leaving the vehicle.

Dual Circuit Brake System

Your vehicle is equipped with a diagonal dual circuit brake system. If one circuit fails, the other circuit can still work.

CAUTION!

If one brake circuit fails to work, you need to press the brake pedal much harder during braking. The braking distance will also increase. When this happens, take your vehicle to an authorized Chery dealer for repair.

Brake Booster

The brake booster provides added braking assist and is controlled by engine vacuum. The brake booster works only when the engine is operating.

CAUTION!

If the vehicle is being towed, the brake booster will not provide the normal braking assist. It will be necessary to press the brake pedal harder to compensate for the booster's loss of assist.

⚠ WARNING!

The brake booster is controlled by engine vacuum and works only when the engine is operating. Therefore, do not turn the engine off and coast while driving down hill.

Operating Cautions**Brake System**

- If there is consistent noise or vibration being transferred to the steering wheel during braking, take your vehicle to an authorized Chery dealer for repair.
- New brake pads require a 200 km break-in period. During the first 200 km, higher pedal pressure will be required for adequate stopping.

- Brake pad wear depends greatly on the driving habits of the operator. For vehicles mainly used for city traffic, frequent starting and stopping will significantly shorten the life of the brake pads. It is necessary to take your vehicle to an authorized Chery dealer for regular maintenance and proper service.
- When driving down a steep grade hill, shift to a lower gear to make full use of the engine's braking action. This will reduce the load on the brake system.
- A damp brake rotor may reduce braking efficiency. After driving through water, driving in a rainstorm, or washing the vehicle, press the brake pedal lightly to dry the brakes and restore normal braking.

⚠ WARNING!

Keeping the brake pressed while driving – commonly known as “riding the brake” – can lead to brake failure and possibly an accident. Driving with your foot resting or “riding” on the brake pedal can result in abnormally high brake temperatures, excessive lining wear, and possible brake damage. This also deteriorates full braking capacity in case of an emergency stop.

Brake Fluid

Check the brake fluid level at regular intervals.

⚠ WARNING!

Add brake fluid to the brake fluid reservoir to maintain the “MAX” level. If a brake fluid leak is suspected, take your vehicle to an authorized Chery dealer for repair.

Antilock Brake System (ABS)

The ABS provides increased vehicle stability and braking performance under most braking conditions. The system automatically modulates brake pressure during severe braking conditions to prevent wheel lockup.

WARNING!

The ABS cannot prevent accidents, including those resulting from excessive speed in turns, following another vehicle too closely, or hydroplaning. Only a safe, attentive, and skillful driver can prevent accidents.

The capabilities of an ABS equipped vehicle must never be exploited in a reckless or dangerous manner, which could jeopardize your safety or the safety of others.

When the brake system goes into an antilock stop, you may also experience the following:

- The ABS motor running (it may continue to run for a short time after the stop)
- The clicking sound of the solenoid valves

NOTE: These are all normal characteristics of ABS.

Utilizing ABS Braking

Firmly pressing the brake pedal in an emergency stop may start the ABS immediately, which will allow you to properly control the vehicle.

WARNING!

Pumping of the antilock brakes will diminish their effectiveness and may lead to an accident. Pumping makes the stopping distance longer. Just press firmly on your brake pedal when you need to slow down or stop.

ABS Self-Check

When the engine is started, you may hear a slight clicking sound as well as some related motor noises. These noises are the ABS performing its self-check cycle to ensure that the system is working properly.

NOTE: If the ABS light comes on while driving, it indicates that the antilock portion of the brake system is not functioning and that service is required.

Power Steering

Power steering is standard equipment on this vehicle. The power steering system will give you good vehicle response and increased ease of maneuverability in tight spaces. The system will provide mechanical steering capability if power assist is lost.

If the power assist is interrupted, it will still be possible to steer your vehicle. Under these conditions, you will feel a substantial increase in steering

effort, especially at very low vehicle speeds and during parking maneuvers.

NOTE: Review the following to avoid damaging the power steering system :

- Prolonged or excessive turns of the steering wheel can increase the steering fluid temperature. This should be avoided when possible as damage to the power steering pump may occur.
- Fill the power steering fluid reservoir once its level is under the "MIN" mark in its reservoir. Do not drive the vehicle with the fluid level below "MIN".

⚠ WARNING!

Continued operation with reduced power steering assist could pose a safety risk to yourself and others.

Check the following if the vehicle is experiencing steering difficulty:

- Tires are properly inflated
- Tires are wearing evenly
- Loose or worn suspension components
- Loose or worn steering components
- Proper wheel alignment

Driving Through Water

Drive carefully and slowly when going through water more than a few inches deep.

CAUTION!

The following guidelines apply to driving through water:

- Never drive through standing water that is deeper than the bottom of your vehicle's tire rims.

(Continued)

CAUTION! *(Continued)*

- Water inside your vehicle's engine can cause it to lockup, stall, or cause serious internal damage.
- Vehicle traction and braking performance will decrease while driving through water.
- Driving through water may cause damage to your vehicle's drivetrain components. Always inspect your vehicle's fluids (e.g., engine oil, transmission, axle, etc.) for signs of contamination (e.g., fluid that is milky or foamy in appearance) after driving through water. Do not continue to operate the vehicle if any fluid appears contaminated as this may result in further damage.

⚠ WARNING!

Driving through water limits your vehicle's braking performance, which increases brake distances. After driving through water, drive slowly and lightly press on the brake pedal several times to dry the brakes.

Getting water inside your vehicle's engine can cause it to lockup, stall, and leave you stranded.

Failure to follow these warnings may result in serious injuries or death for you, your passengers, and others around your vehicle.

Driving In Slippery Conditions

Rapid acceleration on snow covered, wet, or other slippery surfaces may cause the front wheels to pull erratically to the right or left. This phenomenon occurs when there is a difference in the surface traction under the front (driving) wheels.

When driving on wet or slushy roads, it is possible for a wedge of water to build up between the tire and road surface. This is hydroplaning and may cause partial or complete loss of vehicle control and stopping ability. To reduce this possibility, the following precautions should be observed:

- Slow down during rainstorms or when roads are slushy.
- Slow down if the road has standing water or puddles.
- Replace the tires when tread wear indicators first become visible.
- Keep the tires properly inflated.
- Maintain a safe following distance to avoid a collision in a sudden stop.

Tires**General Information**

Tires are designed and engineered for each specific vehicle. They provide the best overall performance for normal operation. The ride and handling

characteristics match the vehicle's requirements. With proper care they will give excellent reliability, traction, skid resistance, and tread life.

Tire Life

The service life of a tire is dependent upon varying factors including but not limited to:

- Driving style
- Tire pressure
- Distance driven

⚠ WARNING!

Tires and spare tire should be replaced after six years, regardless of the remaining tread. Failure to follow this warning can result in sudden tire failure. You could lose control and have an accident resulting in serious injury or death.

Tire Loading

The vehicle maximum load must not exceed the load carrying capacity of

the tires on your vehicle. You will not exceed the tire's load carrying capacity if you adhere to the loading conditions, tire size, and cold tire inflation pressures specified on the Tire and Loading Information placard and in the "Vehicle Loading" section of this manual.

Alignment and Balance

Improper alignment may result in:

- Excessive tire wear
- Uneven tire wear (feathering and one sided wear)
- Vehicle directional pull (left or right)

Tires may also cause the vehicle to pull left or right. Alignment will not correct this problem. Take your vehicle to an authorized Chery dealer for repair.

Tire Chains

Tire chains are used during heavy snow and winter conditions and can only be used on the drive wheels.

WARNING!

Vehicle speed must not exceed 50 km/h when using tire chains.

If equipped with wheel covers, they should be removed before installing tire chains. The wheel covers should be reinstalled once the tire chains have been removed.

Tire Pressure

The proper tire inflation pressure is listed on a placard either on the face of the driver's door or on the driver's side door jam. Proper tire inflation pressure is essential to the safe and satisfactory operation of your vehicle.

Three primary areas are affected by improper tire pressure:

Safety

- Improperly inflated tires are dangerous and can cause accidents.

- Under-inflation increases tire flexing and can result in tire failure.
- Over-inflation reduces a tire's ability to cushion shock.
- Unequal tire pressure can cause steering problems.
- Objects on the road and chuckholes can cause damage that results in tire failure.

Ride Comfort and Vehicle Stability

Proper tire inflation contributes to a comfortable ride. Over-inflation produces a jarring and uncomfortable ride.

Economy

Improper inflation pressure can cause uneven wear patterns to develop across the tire tread. These abnormal wear patterns will reduce tread life, resulting in a need for early tire replacement. Under-inflation, also increases tire rolling resistance and results in higher fuel consumption.

Tire Pressure (Cold Tire) (kPa)

Tire Pressure Chart	Front Tires	Rear Tires	Spare Tire
Summer Pressure	200	200	250
Winter Pressure	220	220	250

NOTE:

- The tire pressure should be checked and adjusted and the tires inspected for signs of wear or visible damage, at least once a month.
- Check tire pressure more often if subject to a wide range of outdoor temperatures, as tire pressure varies with temperature changes.

Tire Rotation

Tires on the front and rear axles of a vehicle operate at different loads and perform different steering, driving, and braking functions. For these reasons, they wear at unequal rates and tend to develop irregular wear patterns. These effects can be reduced by

timely rotation of tires. The benefits of rotation are especially worthwhile with aggressive tread designs such as those on all-season tires. Rotation will increase tread life, help to maintain mud, snow and wet traction levels, and contribute to a smooth, quiet ride. See "Proper Maintenance Of Your Vehicle" for suggested rotation intervals.

NOTE: Tire rotation should be performed every 8,000 km - 10,000 km.

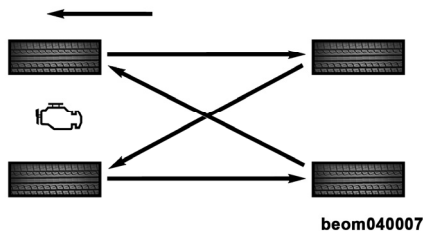

Tire Rotation Direction

Spare Tire

The spare tire is for temporary emergency use. It is engineered to be used on your style vehicle only.

Tread Wear

Tire treads should be checked periodically for any shearing or uneven abrasions. The uneven abrasion of tread indicates a possible incorrect wheel alignment. There are laws regarding tread abrasion depth. Abrasion bands will appear when the tread depth becomes 3 mm. When the tread depth reaches this point the tire must be replaced.



Tread Abrasion Bands

NOTE: Abide by the local environmental protection provisions for the disposal of worn tires.

Once driving conditions permit, replace the winter tires with summer tires to reduce fuel consumption and lower the level of road noise.

Replacement Tires

The tires on your new vehicle provide a balance of many characteristics. When replacing tires, Chery strongly recommends that you use tires equivalent to the originals in size, quality and performance.

WARNING!

Do not use a tire, wheel size, or rating other than that specified for your vehicle. Combinations of unapproved tires and wheels may change suspension dimensions and performance characteristics, resulting in changes to steering, handling, and braking of your vehicle. This can cause unpredictable handling and stress to steering and suspension components. You could lose control and have an accident resulting in serious injury or death. Use only the tire and wheel sizes with load ratings approved for your vehicle.

NOTE: Replacing original tires with tires of a different size may result in false speedometer and odometer readings.

It is strongly recommended to use OEM tires, or refer to an authorized Chery dealer for recommendations when replacing the tires.

Fuel

General Information

Your vehicle is designed to meet all emission regulations and provide excellent fuel economy when using high quality unleaded gasoline with a minimum research octane rating of 93. The vehicle will operate on fuels ranging from regular unleaded having a minimum research octane of 93 to premium unleaded with a minimum research octane of 98.

74 – STARTING AND OPERATING YOUR VEHICLE

Besides using unleaded gasoline with the proper octane rating, gasoline that contains detergents, corrosion and stability additives are recommended. Using gasoline that has these additives may help improve fuel economy, reduce emissions, and maintain vehicle performance.

Poor quality gasoline can cause problems such as hard starting, stalling, and run-on. If you experience these problems, try another brand of gasoline before considering service for the vehicle.

Clean Air Gasoline

Many fuels are now being blended that contribute to cleaner air, especially in those areas where air pollution levels are high. These new blends, sometimes referred to as “reformulated gasoline,” provide a cleaner burning fuel.

Adding Fuel

Fuel Filler Door Release

The fuel filler door can be opened by pulling the fuel filler door release lever on the left side of the driver seat.

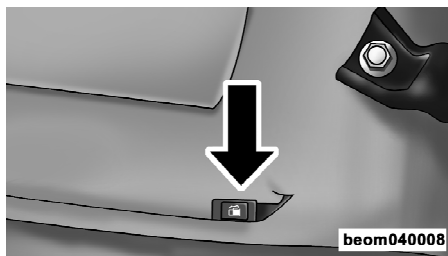

Fuel Door Release Lever

Fuel Filler Cap

The fuel cap is located on the left side of the vehicle. If the fuel cap is lost or damaged, be sure the replacement cap is designed for this vehicle.

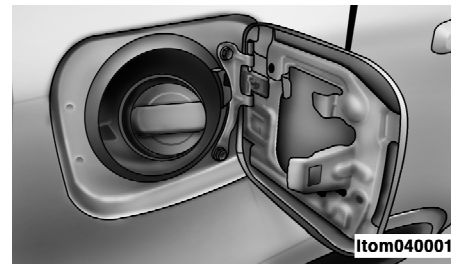

Fuel Filler Cap

NOTE: Damage to the fuel system or emission control system could result from using an improper fuel cap. A poorly fitting cap could let impurities into the fuel system.

Refueling Instructions

Observe the following instructions when refueling:

- Turn the engine off.
- Open the fuel filler door by pulling the fuel filler door release lever.
- Remove the fuel cap by rotating the fuel cap to the left.
- Insert the fuel nozzle to fill the tank. When the fuel nozzle "clicks" or shuts off, the fuel tank is full.

- To replace the cap, insert it into the filler neck and tighten to the right.
- If your vehicle is equipped with a fuel cap that has a tether strap make sure the tether strap is not caught under the fuel cap.

NOTE: To avoid fuel spillage and over-filling, do not "top off" the fuel tank after filling.

⚠ WARNING!

Observe the following guidelines when refueling:

- **Remove the fuel cap (gas cap) slowly to prevent fuel spray from the filler neck which may cause injury.**
- **Never have any smoking materials lit in or near the vehicle when the fuel cap is removed or the tank filled.**
- **Never add fuel to the vehicle when the engine is running.**

YOUR INSTRUMENT PANEL

CONTENTS

▶ Instrument Panel Features	78	▷ Radio Faceplate	86	▷ Remove the Cartridge	93
▷ LHD Instrument Panel Features	78	▷ Radio Faceplate Description	87	▷ Filling The Cartridge	93
▷ RHD Instrument Panel Features	79	▷ Clock Setting	88	▷ Inserting The Cartridge	93
▶ Instrument Cluster	80	▷ Radio Operation	88	▶ Climate Control	93
▷ Instrument Cluster Functions	81	▷ CD Player Operation	90	▷ General Information	93
▶ Audio System	85	▷ CD Changer Operation	91	▷ Air Conditioning and Heating System	94
▷ General Information	85	▷ Remote Audio System Controls (If Equipped)	91	▶ Rear Window Defroster	96
		▶ 6 Disc CD Changer	92	▷ Rear Window Defroster (If Equipped)	96
		▷ General Information	92		

Instrument Panel Features

LHD Instrument Panel Features

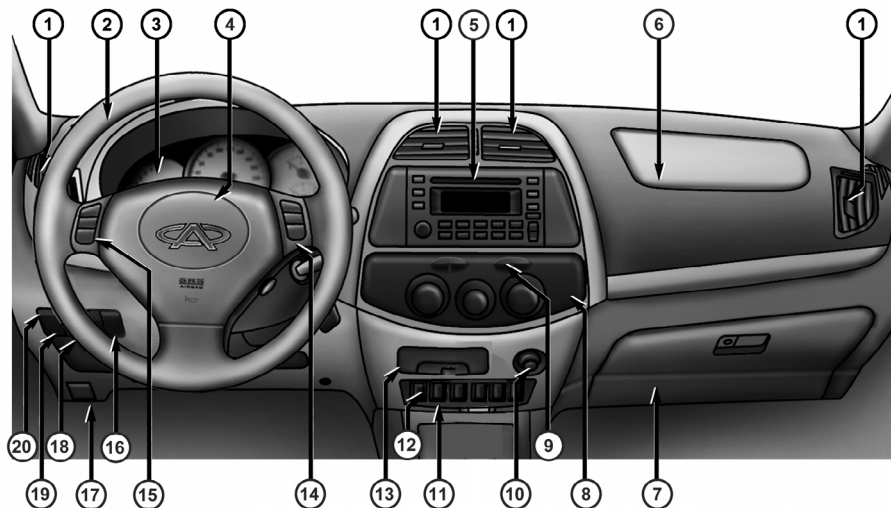

Item050001

- | | | | | |
|------------------------|---------------------------|-----------------------------------|-----------------------------------|--------------------------------|
| 1 - Air Outlet | 5 - Radio | 9 - Hazard Warning Flasher Switch | 13 - Front Ashtray | 17 - Hood Release Lever |
| 2 - Steering Wheel | 6 - Passenger Side Airbag | 10 - Cigarette Lighter | 14 - Cruise Control Switch | 18 - Headlight Leveling Switch |
| 3 - Instrument Cluster | 7 - Glove Box | 11 - RH Heated Seat Switch | 15 - Remote Audio System Controls | 19 - Rear Fog Light Switch |
| 4 - Driver Side Airbag | 8 - Climate Control Panel | 12 - LH Heated Seat Switch | 16 - Dimmer Control Switch | 20 - Front Fog Light Switch |

RHD Instrument Panel Features

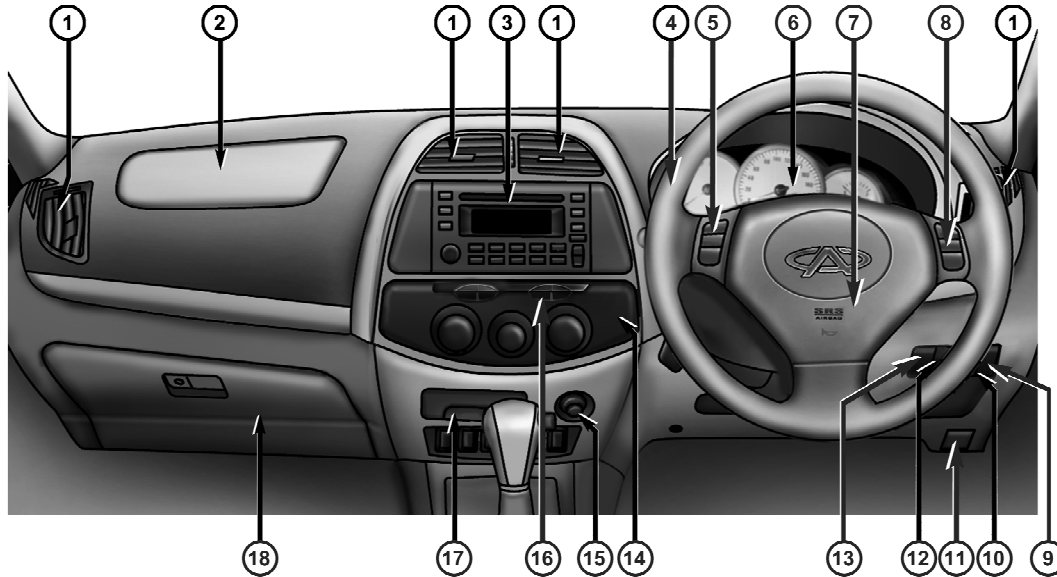

Item050002

- | | | | | |
|---------------------------|----------------------------------|--------------------------------|------------------------------------|--------------------|
| 1 - Air Outlet | 5 - Remote Audio System Controls | 9 - Front Fog Light Switch | 13 - Dimmer Control Switch | 17 - Front Ashtray |
| 2 - Passenger Side Airbag | 6 - Instrument Cluster | 10 - Rear Fog Light Switch | 14 - Climate Control Panel | 18 - Glove Box |
| 3 - Radio | 7 - Driver Side Airbag | 11 - Hood Release Lever | 15 - Cigarette Lighter | |
| 4 - Steering Wheel | 8 - Cruise Control Switch | 12 - Headlight Leveling Switch | 16 - Hazard Warning Flasher Switch | |

Instrument Cluster

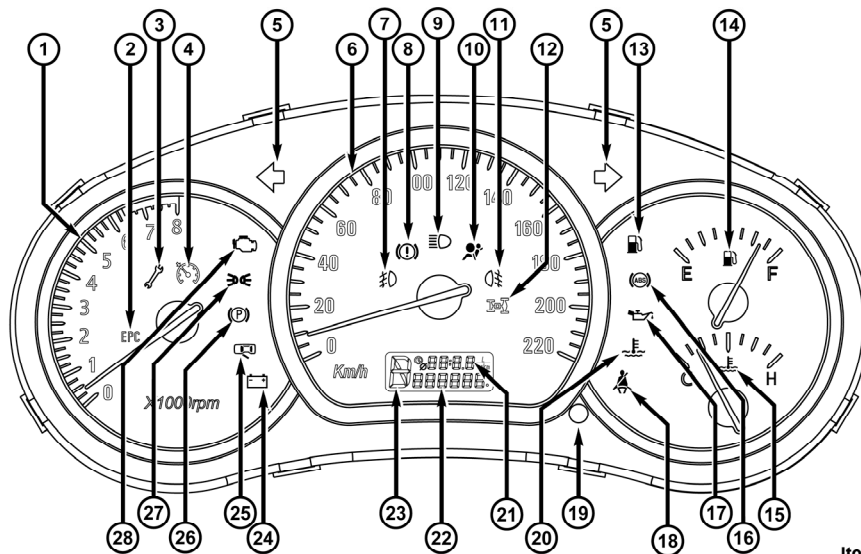

Item050003

Instrument Cluster Functions

1. Tachometer

The white area of the scale shows the permissible engine revolutions-per-minute (rpm x 1000) for each gear range. Before the tachometer reaches the red area, ease up on the accelerator to prevent engine damage.

2. Electronic Throttle Control Indicator Light

EPC

This light will turn on briefly as a self-check when the ignition switch is turned ON.

This light informs you of a problem with the Electronic Throttle Control system. When a problem is detected, the light will illuminate while the engine is running. If the light turns on while the engine is running, safely bring the vehicle to a complete stop as soon as possible, place the shift lever in PARK, and cycle the ignition key. The light should turn off. If the light remains lit with the engine

running, your vehicle will usually be drivable. Nonetheless, see your authorized Chery dealer for service as soon as possible.

3. Maintenance Indicator Light



Every 5,000 km this warning light will illuminate as a reminder that the vehicle should be returned to your authorized Chery dealer for maintenance.

4. Cruise Indicator



This indicator shows when the Cruise Control system is turned ON.

5. Turn Signal Indicator Light



The left or right arrow will flash in unison with the corresponding front and rear turn signal lights when the turn signal switch is operated. Refer to “Lights” in Chapter 3 of this manual for more information.

6. Speedometer

The Speedometer indicates vehicle speed in kilometers per hour (km/h).

NOTE: Use the tires designated for your vehicle. Otherwise the speedometer will not indicate the correct vehicle speed.

7. Front Fog Light Indicator Light



This light illuminates when the front fog lights are ON.

8. Brake System Warning Light



This light monitors various brake functions, including brake fluid level and brake application. If the light illuminates it may indicate that the brake fluid level is low or that there is a problem with the brake system. When this light is on, you should check whether the brake fluid level is too low. If the brake fluid level is too low,

you should fill the brake fluid immediately to the level between "MIN" and "MAX". Have the system checked by an authorized Chery dealer. The dual brake system provides a reserve braking capacity in the event of a failure to a portion of the hydraulic system. Failure of either half of the dual brake system is indicated by the Brake Warning Light, which will turn on when the brake fluid level in the master cylinder has dropped below a specified level. The light will remain on until the cause is corrected.

WARNING!

Driving a vehicle with an illuminated brake system warning light and an anti-lock warning light is dangerous. Part of the brake system may have failed. It will take longer to stop the vehicle. You could have an accident. Have the vehicle checked immediately.

9. High Beam Indicator Light



This light shows that the headlights are on high beam. Push the Multifunction lever away from you to switch the headlights to high beam. Pull the lever toward you, to switch the headlights back to low beam.

10 . Airbag Light



This light illuminates for three to four seconds as a bulb check when the ignition switch is first turned ON. If the light does not illuminate during starting, stays on, or turns on while driving, have the system checked by an authorized Chery dealer.

11. Rear Fog Light Indicator Light



This light illuminates when the rear fog lights are ON.

12. 4WD Indicator Light



This light illuminates when the 4WD system is turned ON.

13. Low Fuel Warning Light



This indicator lights when the fuel level drops to no more than 10 liters. The fuel gauge pointer will be in the red area. When this indicator lights, you should fill the fuel tank as soon as possible.

14. Fuel Gauge

The fuel gauge indicates the amount of fuel the vehicle has in the fuel tank.

NOTE: When the ignition switch is turned to OFF, the fuel and temperature gauges may not show accurate readings. When the engine is not running, turn the ignition switch to ON to obtain accurate readings.

15. Coolant Temperature Gauge

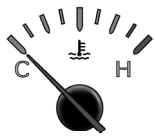

Item050022

The temperature gauge shows engine coolant temperature. Any reading within the normal range indicates that the engine cooling system is operating properly. The pointer may show a higher than normal temperature when driving in hot weather, up mountain grades, in heavy stop-and-go traffic, or when towing a trailer. The instrument cluster will sound a chime when the pointer rises to the "H" (red) mark. If this occurs, safely pull over and stop the vehicle. Then idle the vehicle with the air conditioner turned off until the pointer drops back into the normal range. If the pointer remains on the "H" (red) mark, turn the engine off immediately and call for service.

16. Anti-Lock Brake Warning Light (ABS)



This light monitors the Anti-Lock Brake System (ABS). The light will turn on when the ignition switch is turned to the ON position and may stay on for several seconds. During this time, the ABS is performing its self-check cycle to ensure that the system is working properly. If the light remains on or turns on while driving, it indicates that the Anti-Lock portion of the brake system is not functioning and that service is required. However, the conventional brake system will continue to operate normally, provided the BRAKE warning light is not on. If the ABS light is on, the brake system should be serviced as soon as possible to restore the benefit of Anti-Lock brakes. Refer to "Brake System" in Chapter 4 of this manual for more information.

17. Oil Pressure Light



This light shows low engine oil pressure. The light will turn on and remain on for several seconds when the ignition switch is turned from the LOCK or ACC position to the ON position. The light will turn off after the engine is started. If the light does not turn on during starting, have the system checked by an authorized Chery dealer. If the light turns on and remains on while driving, safely bring the vehicle to a stop and shut the engine off. Check the engine oil level and verify it is in the proper operating range. If the oil pressure light remains on, have the vehicle towed to an authorized Chery dealer.

18. Seat Belt Reminder Light



This light will illuminate for about six seconds when the ignition switch is first turned ON. If you have not pulled

the shoulder belt out of the retractor, this light will turn on. This is a reminder to buckle your seat belt. This light will remain on until you buckle your seat belt.

19. Trip Odometer/Digital Clock Button

Trip Odometer - Press and release this button to change the display from odometer to trip odometer. Press and release the button again to change the display back to the odometer. To reset the trip odometer, first set the display to Trip Mode. Then push and hold the button until the display resets to 0. The odometer must be in Trip Mode to reset the trip odometer.

Digital Clock - Press and hold the button for a few seconds to adjust the clock. Adjust both the hour and the minutes through this button.

20. Coolant Temperature Warning Light



This light warns of an overheated engine condition. If the engine is critically hot, the instrument cluster will sound a chime. After the chime turns off, the engine will still be critically hot until the light goes out.

21. Digital Clock

This display indicator shows the time.

22. Odometer/Trip Odometer

Odometer - The odometer shows the total distance the vehicle has been driven.

Trip Odometer - The trip odometer shows individual trip mileage since the trip odometer was last set to zero.

23. Transaxle Range Indicator (If Equipped)

This display indicator shows the automatic transaxle gear selection.

24. Charging System Light



This light shows the status of the electrical charging system. The light should illuminate when the ignition switch is first turned ON and remain on briefly as a bulb check. If the light remains on or turns on while driving, turn off some of the vehicle's electrical devices, such as the fog lights or rear defroster. If the light remains on, it indicates that the charging system is experiencing a problem. See your authorized Chery dealer for service immediately.

25. Door Open Warning Display



When the ignition switch is ON, this display indicates the condition of the vehicle's five doors.

26. Parking Brake System Warning Light



The Parking Brake Warning Light will illuminate and stay on briefly as a bulb check when the ignition is first turned on. This indicator lights when the parking brake is operated.

27. Position Light Indicator Light



This light illuminates when the parking lights or headlights are turned ON.

28. Malfunction Indicator Light



This light is part of an On-board Diagnostic System (OBD) that monitors emissions, engine, and automatic transmission control systems. The light will illuminate when the key is in the ON position before the engine starts. If the light does not turn on when turning the key from LOCK or

ACC to ON, have the condition checked promptly. If the Malfunction Indicator Light turns on when the engine is running, the vehicle should be serviced as soon as possible.

Audio System

General Information

The radio will provide excellent reception under most operating conditions. However, like any system, radios have performance limitations. To help you understand and avoid concern about these possible malfunctions, you must understand how radio signals are transmitted and received.

Radio Signals

There are two basic types of radio signals:

- AM (Amplitude Modulation), in which the transmitted sound causes the amplitude, or height of the radio waves to vary.

- FM (Frequency Modulation), in which the frequency of the wave is varied to carry the sound.

AM Reception

AM sound is based on wave amplitude, so AM reception can be disrupted by such things as lightning, power lines and neon signs.

FM Reception

Because FM transmission is based on frequency variations, interference that consists of amplitude variations can be filtered out, leaving the reception relatively clear, which is the major feature of FM radio.

Radio Faceplate

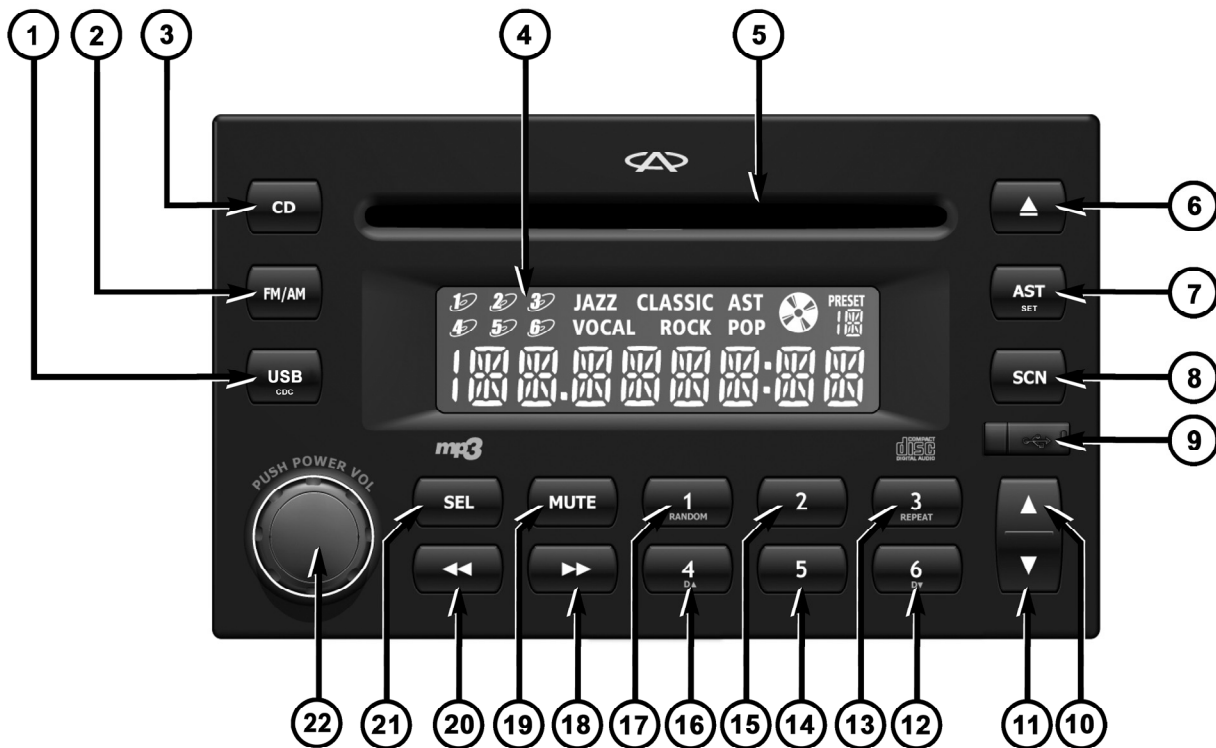

Item050004

Radio Faceplate Description

1. CDC - CD Changer Player Mode	2. FM/AM - FM/AM Play Mode	3. CD - CD Player Mode	4. LCD Display
5. CD Opening	6. Eject CD	7. AST/SET • AST - Auto Store • SET - Enter Setup Mode	8. SCN • Tuner's Frequency Scan (tuner) • CD/MP3 Disc Stack Scan (CD/MP3 Player)
9. USB Connector	10. Next Track (CD/MP3 Disc / USB Player Mode)	11. Previous Track (CD/MP3 Disc / USB Player Mode)	12. Preset Button 6 (Turner) / Select Previous Disc (CD Changer)
13. Preset Button 3 (Tuner) / REPEAT - CD/MP3 Repeat Track ON/OFF	14. Preset Button 5 (Turner)	15. Preset Button 2 (Tuner)	16. Preset Button 4 (Turner) / Select Next Disc (CD Changer)
17. Preset Button 1 (Tuner) / RANDOM - CD/MP3 Random Track ON/OFF	18. Search For Higher Frequency (Tuner) / Fast Forward / Resume (CD/MP3 Player)	19. MUTE - Set Mute	20. Search For Lower Frequency (Tuner) / Fast Rewind / Resume (CD/MP3 Player)
21. SEL - Audio Setting	22. PWR - Power/Volume Knob		

Clock Setting

- Press SET button for more than 2 seconds to enter the SET UP menu.
- Press Next Track button until you reach the option TIME.
- Press SET button to alter the 12H or 24H.
- Press Next Track button to select hour digit.

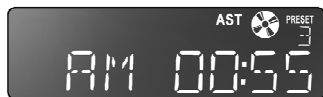

beom050023

Clock Setting

- Press SET button to adjust the hour digit.
- Press Next Track button to select the minute digit.
- Press SET button to adjust the minute digit.
- Press Previous Track button to select the hour digit.
- Press SET button for more than 2 seconds to leave the SET UP menu.

10 seconds after any key operation, the display will always show the time when the clock mode is activated.

Radio Operation

ON/OFF

Press the power/volume knob to turn the radio ON or OFF.

Volume

Turn the power/volume knob to adjust the volume. To increase volume, turn

the knob clockwise. Turn it counter-clockwise to decrease volume. The volume range is from 0 (minimum) to 33 (maximum).

NOTE: Please make sure you can still hear the traffic (horns, sirens...).

Audio Setting

Press SEL button to enter the audio setting mode. Turn the power/volume knob to setting the selected option.

- BASS – To increase or decrease bass
- TREBLE – To increase or decrease treble
- BAL – To move the sound to the right or left speaker, or balance the sound between the speakers
- FADER – To move the sound to the front or rear speakers, or balance the sound between the speakers
- LOUD (off, low, mid, high)
- Sound Style – Preset settings for JAZZ, VOCAL, POP, CLASSIC, or ROCK

After five seconds, the display returns to the last mode of operation.

NOTE: You can only adjust the "BAL", "FADER" and "LOUD" audio mode if not in the "BAL - TRE" mode.

Waveband

Press the FM/AM button to select the desired band: FM1 → FM2 → FM3 → AM → FM1...

Frequency Scan (SCN)

Press SCN button to activate/deactivate Frequency Scan. Frequency scan allows you to listen to each station found on the current band for about 10 seconds. In the meantime, you can store each station in 10 seconds.

Auto Search

- Press the forward button to tune to a station of a higher frequency or rewind button to tune to a lower frequency.

- To search for another station, press the forward or rewind button again.

Frequency Sensitive (Only In FM Band)

Switch between local/distance tuning mode.

- Press SET button for more than 2 seconds to enter the SET UP menu.
- Press Next/Previous Track button to select the SRCH option.
- Press SET button to set LO/DX.
- Press SET button for more than 2 seconds to leave the SET UP menu.

Manual Tuning

Switch to manual tuning mode, please perform the following procedures.

- Press SET button for more than 2 seconds to enter the SET UP menu.
- Press Next/Previous Track button to select the TUN option that you want to change.
- Press SET button for more than 2 seconds to enter the SET UP menu, and

setting the value as "MAN", set will keep in manual tuning mode until you set it back to "AUTO".

- Press SET button for more than 2 seconds to exit the SET UP menu.
- Press the Rewind button to tune to a station of a lower frequency.
- Press the Forward button to tune to a higher frequency.

Automatically Storing Stations

You can automatically store 6 strongest FM stations on the FM AST band or 6 strongest AM stations on the AM AST band. When you use auto store, the new stations replace any stations previously stored in the FM AST band or the AM AST band.

To automatically store a station to memory, perform the following procedures:

- Press AST button on the radio faceplate to activate autostore.

- The set gives a beep and then mute, the display is blinking.
- When it has finished, you hear a beep followed by the station stored on preset 1-6, and the display stops blinking.
- Sometimes it may not be possible to find 6 stations.

Preset Stations (1-6)

Six stations per band can be stored and recalled using the preset buttons (1 to 6).

- Tune in to the desired station.
- Press the desired preset button (1 to 6) for more than 2 seconds (till you hear a "beep") to store the current tuned station into.

CD Player Operation

CD Play

Press CD button to enter the 6 discs CD player mode.

Display shows:

- Audio mode (if selected)
- CD playing symbol
- Current playing track number, played time.

Scan Track

The scan function enables you to listen to the first 10 seconds of each track.

- Press SCN button to activate Scan Track.
- Press SCN button again to deactivate Scan Track.

Previous / Next Track

- Press Next/Previous Track button to select the next / previous track.
- CD player resumes to play mode after the selection is completed.

Fast Backward / Forward

- Press the Rewind or Forward button to quickly move rewind or forward through the disc.

- Press the Rewind or Forward button again to return to CD play mode.

Random Track Play

- Press RANDOM button more than 2 seconds to enter random track play mode.
- Press RANDOM button again to exit the random track play mode.

Repeat Track Play

- Press REPEAT button more than 2 seconds to enter repeat current track play mode.
- Press REPEAT button again to exit the repeat track play mode.

Eject Disc

Press Eject button to eject the disc.

Maintenance for CD

- Avoid making fingerprints on the disc when you take it out.
- Put the disc back in its box immediately after eject it, to protect the disc from dirt and dust.

- Do not expose the disc to heat or direct sunlight.

CD Changer Operation

CD Changer Play

- Connect a compatible VDO CD changer to CD player.
- Press CDC button to select CD changer play mode.

Displayer shows:

- Audio mode (if selected)
- CD playing symbol
- Current playing track number, played time.
- Press Previous Disc button or Next Disc button to select the desired disc.

Track Scan

The scan function enables you to listen to the first 10 seconds of each track.

- Press SCN button to activate scan track.
- Press SCN button again to deactivate scan track.

Repeat Track Play

- Press REPEAT button to enter repeat current track play mode.
- Press REPEAT button again to exit the repeat track play mode.

Random Track Play

- Press RANDOM button to enter random track play mode.
- Press RANDOM button again to exit the random track play mode.

Previous / Next Track

- Press Next/Previous Track button to select the next / previous track.
- CD player resumes to play mode after the selection is completed.

Fast Backward / Forward

- Press the Rewind or Forward button to quickly move rewind or forward through the disc.
- Press the Rewind or Forward button again to return to CD play mode.

Remote Audio System Controls (If Equipped)

The remote audio system controls are located on the surface of the steering wheel.

Left-Hand Switch Functions for Radio Operation



Item050016

Remote Audio System Controls - Left-Hand Switches

- Press Next Track button to select higher frequency (Tuner) / fast forward (CD/MP3 Player).
- Press the "SRC" button to change modes (i.e., AM, FM, CD, etc.).

- Press Previous Track button to select lower frequency (Tuner) / fast rewind (CD/MP3 Player).

Right-Hand Switch Function for Radio Operation (If Equipped)

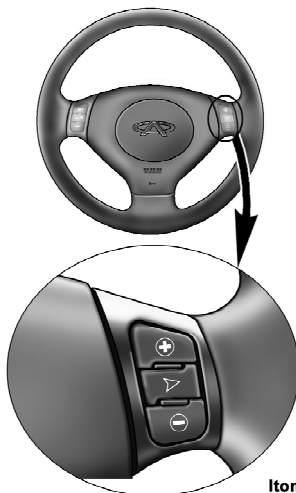

Item050017

Remote Audio System Controls - Right-Hand Switches

- Press the volume (+) button to increase volume.

- Press the volume (-) button to decrease volume.
- Press the middle button to change the disc or search for the next frequency.

6 Disc CD Changer

General Information

The 6 disc CD changer is located at the bottom of the front passenger side seat, near the floor.

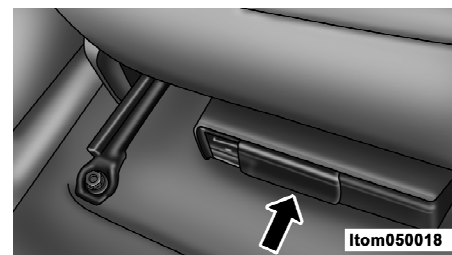

6 Disc CD Changer Location

Remove the Cartridge

- Open the slide door.

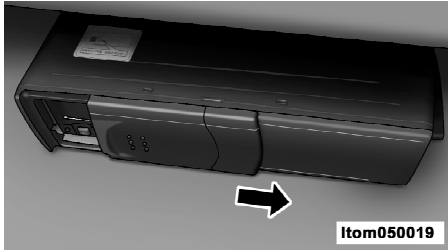

Opening The Changer Sliding Door

- Press the Eject button and pull the cartridge out of the CD changer.

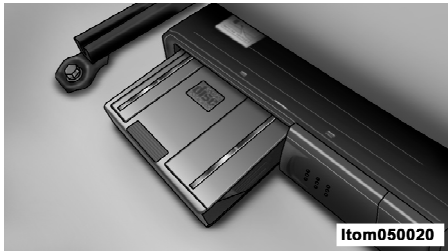

Removing The CD Cartridge

- Close the slide door.

Filling The Cartridge

- Pull the tab on the cartridge's disc tray to remove one of the trays.



Filling The Cartridge

Place the disc on the tray with the label side up.

- Each tray can accommodate only one disc.
- The CD changer will function if the discs are placed upside down.

Press the tab on the disc tray to store the tray back in the cartridge.

Inserting The Cartridge

Inserting the cartridge is in the reverse order of removal.

NOTE: Refer to your “6 CD Changer User Manual” for detailed operating instructions.

Climate Control

General Information

The air conditioning and heating system is designed to make you comfortable in all types of weather.

The air conditioner will absorb moisture in the air and collect on the evaporator. This moisture then drains out of the evaporator under the vehicle.

NOTE: While parked, a small puddle of water gathered under the vehicle while operating the air conditioning is considered normal.

Fresh Air Filter



Fresh Air Filter Location

The fresh air filter prevents most dust and pollen from entering the passenger compartment. The filter acts on air coming from outside the vehicle and recirculated air within the passenger compartment. The filter can be washed periodically as needed.

Air Conditioner System Performance

If your air conditioning performance seems lower than expected, check the front of the A/C condenser located in front of the radiator for an accumulation of dirt or insects. Clean with a

gentle water spray from behind the radiator and through the condenser.

NOTE: Front fascia protectors may reduce airflow to the condenser, reducing air conditioning performance.

For best air conditioner performance, select the recirculation mode while operating the air conditioning system.

Heater System Performance

Heater performance is dependant on the temperature of the engine coolant. Therefore, the vehicle must be at proper operating temperature before the heating system will perform to its full potential.

Air Conditioning and Heating System



Itom050005

Temperature Control Panel

The air conditioning and heating system allows you to select the following:

- Blower motor speed (controls four speeds)
- Discharge air temperature (temperature blend)
- Discharge air direction (panel, bi-level, floor, mix, defrost)
- A/C compressor operation (controls ON/OFF function)
- Air inlet source (outside air/recirculated air)

Blower Control



Item050008

Use this control to regulate the amount of air forced through the ventilation system in any mode. The blower speed increases as the control is moved to the right from the OFF position. There are four blower speeds.

Temperature Control



Item050007

Use this control to regulate the temperature of the air inside the passenger compartment. The blue area of the scale indicates cooler temperatures; the red area indicates warmer temperatures.

Mode Control (Air Direction)

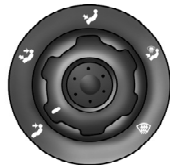

Item050009

Use this control to choose from several patterns of air distribution.

Panel

 Airflow is directed through the outlets in the instrument panel. These outlets can be adjusted to direct airflow.

Bi-Level

 Airflow is directed through the instrument panel and floor outlets.

Floor

 Airflow is directed through the floor outlets with a small amount flowing through the defrost and side window defog outlets.

Mix

 Airflow is directed through the floor, defrost, and side window defog outlets. This setting works best in cold or snowy conditions that require extra heat to the windshield. This setting is good for maintaining comfort while reducing moisture on the windshield.

Defrost

 Airflow is directed through the outlets for the windshield and side window defrosters. Use this mode with maximum blower and temperature settings for best windshield and side window defrosting.

Air Conditioner Control



Item050010

Press this button to turn on the air conditioner. When the air conditioner is turned on, cool dehumidified air will flow through the outlets selected with the Mode control dial. An LED in the button illuminates when manual compressor operation is selected.

Recirculation Control



Item050012

Press the recirculation button to recirculate the air inside the vehicle. Use the recirculation mode to rapidly cool the inside of the vehicle. The recirculation mode can also be used to temporarily block outside odors, smoke, and dust, or when high

humidity is present. Activating recirculation will cause the LED in the control button to illuminate.

Rear Window Defroster

Rear Window Defroster (If Equipped)



Item050011

The rear window defroster button is located on the climate control panel. Press the rear window defroster button to turn on the rear window defroster and the heated outside mirrors (if equipped). An indicator in the button will illuminate when the rear window defroster is on. The rear window defroster automatically turns off after approximately 10 minutes. Pressing the button again before the 10 minute time out period will deactivate the rear window defroster.

CAUTION!

Use the following care for the rear window:

- Do not use abrasive window cleaners on the interior surface of the window.
- Use a soft cloth and a mild washing solution, wiping parallel to the heating elements.
- Labels can not be peeled off unless soaking with warm water.
- Do not use scrapers, sharp instruments, or abrasive window cleaners on the interior surface of the window.

IN CASE OF AN EMERGENCY

CONTENTS

▶ Hazard Warning Flasher	98	▷ Jacking Instructions	99	▶ Towing A Disabled Vehicle	104
▶ Jacking and Tire Changing	98	▷ Wheel Nut Torque Specification	101	▶ Removing and Installing Vehicle Battery	104
▷ Jack Location	98	▶ Vehicle Overheating	101	▶ Jump-Starting Procedures Due to A Low Battery	105
▷ Spare Tire Location	98	▶ Fuse Replacement	103		
▷ Preparations for Jacking	99				

Hazard Warning Flasher



The hazard switch is located on the instrument panel, above the climate control panel. Depress the switch to activate both cluster indicators and all front and rear directional signals. Depress the switch again to turn the Hazard Warning Flashers off. This is an emergency warning system and it should only be used for emergencies. Use it when your vehicle is disabled or creating a safety hazard for other motorists.

The hazard warning flashers will continue to operate even though the ignition switch is on the LOCK position.

NOTE: With extended use, the hazard warning flashers may drain the battery.

Jacking and Tire Changing

Jack Location

The jack is stowed under the load floor in the cargo area.

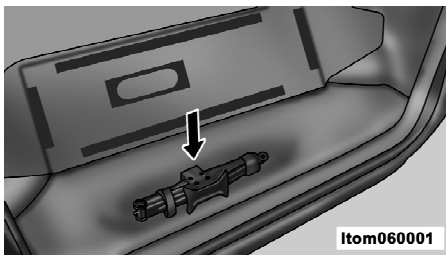

Jack Storage Location

NOTE: The maximum working load of the jack is 800 kg.

Spare Tire Location

The spare tire is stowed on the back door.



Itom060007

Spare Tire Location

Spare Tire Removal

- Release the spare tire cover clasp.

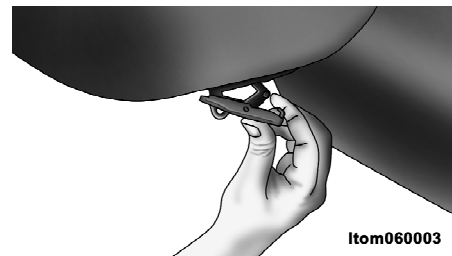

Itom060003

Releasing The Spare Tire Cover Clasp

- Remove the spare tire cover.

- Remove the spare tire retaining bolts.



Removing The Spare Tire Retaining Bolts

- Remove the spare tire.

Preparations for Jacking

- Park the vehicle on a firm, level surface. Avoid steep, icy, or slippery areas.

- Set the parking brake firmly. For vehicles equipped with an automatic transaxle, place the vehicle in PARK. For a manual transmission equipped vehicle, place the transaxle in REVERSE.
- Turn off the engine.
- Turn on the hazard warning flashers.
- Put wheel blocks at the front and rear of the tire diagonally opposite the tire being changed. For example, if changing the right front tire, block the left rear wheel.

⚠ WARNING!

Do not attempt to change a tire on the side of the vehicle close to moving traffic. Pull far enough off the road to avoid the danger of being hit when operating the jack or changing the tire.

Jacking Instructions

- Remove the spare tire, jack, and jack-handle.
- Loosen, but do not remove, the wheel nuts on the wheel with the flat tire. Turn the wheel nuts counterclockwise while the wheel is still on the ground.
- Place the jack underneath the lift area that is closest to the flat tire. Turn the jack screw clockwise to firmly engage the jack saddle with the lift area of the sill flange.



Item060005

- Raise the vehicle by turning the jack screw clockwise with the jack handle. Raise the vehicle until the tire just clears the ground surface and there is enough clearance to install the spare tire.

⚠ WARNING!

Minimum tire lift provides maximum stability.

- Remove the wheel nuts.
- Remove the wheel and tire assembly from the hub.
- Install the spare tire.
- Install the wheel nuts with the tapered end of the nuts toward the wheel. Lightly tighten the nuts by hand.
- Lower the vehicle by turning the jack screw counterclockwise with the jack handle.

- Finish tightening the wheel nuts. Alternate tightening wheel nuts firmly in a criss-cross pattern until each nut has been tightened twice. Correct wheel nut torque is 110 N•m.

CAUTION!

To verify correct wheel nut torque, have them checked with a torque wrench by your authorized Chery dealer as soon as possible after the repair.

- Lower the jack to its fully closed position.
- Stow the jack-handle and jack.
- Place the flat tire in the trunk. Have it repaired or replaced as soon as possible.

Wheel Nut Torque Specification

Description	Torque (N•m)
Wheel Nuts	110

Vehicle Overheating

⚠ WARNING!

A hot engine cooling system is dangerous. You or others could be badly burned by steam or boiling coolant. You should call a service station for help if your vehicle overheats.

If your engine coolant temperature gauge indicates overheating, if you experience a loss of power, or if you hear a loud knocking or pinging noise, the engine has probably overheated. You should perform the following procedure.

- Pull over the vehicle, stop the vehicle and turn on your hazard warning flasher. Put the transaxle in "P" (automatic) or neutral (manual) and apply the parking brake. Turn the air conditioner off if it is being used.

- If coolant or steam is boiling out of the radiator or reservoir, stop the engine. Wait until steam subside before opening the hood. If there is no coolant boiling over or steam, leave the engine running and make sure the electric cooling fan is operating. If it is not, turn the engine off and let it cool.

CAUTION!

To help avoid personal injury, keep the hood closed until there is no steam. Escaping steam or coolant is a sign of very high pressure.

- Look for obvious coolant leaks from the radiator, hoses, and under the vehicle. However, note that water draining from the air conditioning is normal if it has been used.

CAUTION!

When the engine is running, keep hands and clothing away from the moving fan and engine drive belts.

- If the coolant is leaking, stop the engine immediately. Call an authorized dealer for assistance.
- If there are no obvious leaks, check the coolant reservoir. If it is dry, add coolant as required. See "Adding Coolant" in the "Proper Maintenance Of Your Vehicle".

CAUTION!

Do not attempt to remove the radiator cap when the engine and radiator are hot. Serious injury could result from scalding hot fluid and steam blown out under pressure.

- After the engine coolant temperature has cooled to normal, double check the coolant level in the reservoir. If necessary, bring it up to half full again. Serious coolant loss indicates a leak in the system. You should have it checked as soon as possible at your authorized dealer.

NOTE: If the engine continues to overheat or frequently overheats, have the cooling system inspected by your authorized dealer as soon as possible.

Fuse Replacement

Fuses are used to protect electrical circuitry and components from a possible electrical overload. If a fuse fails on your vehicle, see the fuse application chart to replace the fuse with the proper amperage.

⚠ WARNING!

Turn the ignition switch OFF before replacing any fuse.

CAUTION!

When replacing a blown fuse, it is important to use only a fuse having the correct amperage rating. The use of a fuse with a rating other than indicated may result in a dangerous electrical system overload. If a properly rated fuse continues to blow, it indicates a problem in the circuit that must be corrected.

The Front Fuse and Relay Box is located in the engine compartment.

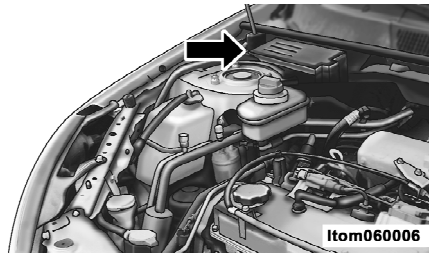

Front Fuse and Relay Box Location

Spare fuses should be carried in the vehicle in case any fail. Your authorized Chery dealer stocks various types of fuses required for your vehicle.

CAUTION!

When installing the Front Fuse and Relay Box cover, it is important to ensure the cover is properly positioned and fully latched. Failure to do so may allow water to enter and possibly result in an electrical system failure.

A blown fuse can be identified by the melted fuse wire.



beom080005

Fuse Color	Amperage
Auburn	5 A
Brown	7.5 A
Red	10 A
Blue	15 A
Yellow	20 A
Green	30 A

Fuse Color	Amperage
Pink	40 A
Yellow	60 A

Towing A Disabled Vehicle

NOTE: Your vehicle is equipped with tow hooks at both the front and rear.

CAUTION!

Observe the following guidelines when towing the vehicle:

- Tow the vehicle slowly and smoothly to avoid damage.
- If the vehicle needs to be steered while being towed, the ignition switch must be in the ON position, not in the LOCK or ACC position.
- Power brake and power steering assist is not unavailable when the engine is off, the required operational force is increased significantly.

(Continued)

CAUTION! (Continued)

- Do not attempt to tow this vehicle from the front with sling type towing equipment. Damage to the front fascia will occur.

Removing and Installing Vehicle Battery

The following steps must be taken when removing and installing the battery:

- Turn the ignition switch and all electrical devices off.
- Remove the negative (-) battery cable.

- Remove the protective cover from the positive (+) battery cable, and remove the cable.
- Remove the battery hold down, and remove the battery.
- Install the new battery, when installing the battery, connect the positive (+) battery cable first and then the negative (-) battery cable.
- After the new battery is installed, the vehicle may perform unusually while driving. This is normal due to the engine control system readapting to the vehicle's driving conditions.

NOTE: Please discard the used battery for disposal to an authorized dealer or local qualified waste disposal station.

Jump-Starting Procedures Due to A Low Battery

WARNING!

Observe the following guidelines when jump-starting the battery:

- Take care to avoid the radiator cooling fan whenever the hood is raised. It can start anytime the ignition switch is ON. You can be hurt by the fan.

(Continued)

WARNING! *(Continued)*

- Do not attempt to push or tow your vehicle to get it started. Vehicles equipped with an automatic trans-axle cannot be started this way. Unburned fuel could enter the catalytic converter and once the engine has started, ignite and damage the converter and vehicle. If the vehicle has a discharged battery, booster cables may be used to obtain a start from another vehicle. This type of start can be dangerous if done improperly, so follow this procedure carefully.
- The battery used for boosting must be 12 volts.

The following preventative measures must be taken when jump starting the vehicle:

- When boosting from a battery in another vehicle, park that vehicle within booster cable reach, but without allowing the vehicles to touch.
- Set the parking brake.
- Place an automatic transaxle equipped vehicle in PARK, and a manual transaxle equipped vehicle in NEUTRAL.
- Turn the ignition switch to LOCK for both vehicles.
- Turn off all unnecessary electrical loads.
- Remove the protective cover over the positive battery post (+). Connect one end of the jumper cable to the positive battery post. Connect the other end of the same cable to the positive terminal of the booster battery.
- Connect the other cable, first to the negative terminal of the booster battery and then to the battery ground (-) of the vehicle with the discharged battery. Make sure you have a good connection on the engine ground.
- Start the engine in the vehicle that has the booster battery, let the engine idle for a few minutes, and then start the engine in the vehicle with the discharged battery.
- When removing the jumper cables, reverse the sequence exactly. **Be careful of the moving belts and fan.**
- Reinstall the protective cover over the positive battery post (+).

CUSTOMER ASSISTANCE

CONTENTS

▶ Service for Your Vehicle	108	▶ If You Need Assistance	108	▷ After-Sales Service	
▷ Service Appointments	108	▷ Vehicle Satisfaction	108	Department Chery	
▷ Service List	108	▷ Authorized Chery Dealer		International	109
▷ Service Requests	108	Service	108		

Service for Your Vehicle

Service Appointments

If you're having warranty work done, be sure to have the proper vehicle documents with you. Take your warranty folder. All work to be performed may not be covered by the warranty. Discuss additional charges with the service advisor. Keep a maintenance log of your vehicle's service history. This can often provide a clue to the current problem.

Service List

Prepare a written list of your vehicle's problems or the specific work you want done. If you've had an accident or work done that is not on your maintenance log, let the service advisor know.

Service Requests

If you list a number of items and you must have your vehicle by the end of the day, discuss the situation with the

service advisor and list the items in order of priority. At many authorized Chery dealers, you may obtain a rental vehicle at a minimal daily charge. If you need a rental, it is advisable to make these arrangements when you call for an appointment.

If You Need Assistance

Vehicle Satisfaction

Chery and its authorized dealers are committed to your satisfaction with their products and services. Your happiness with our vehicle is important to us.

If a service problem or other difficulty occurs, we recommend that you take the following steps:

- Discuss the problem with your authorized Chery dealership's service manager. Management personnel at the authorized dealer are in the best position to resolve your questions and concerns quickly.

- In the event you are still not satisfied, talk to the general manager or the owner of the authorized dealership. They want you to be satisfied.
- If the dealership is unable to resolve your concern, please contact the After-Sales Service Department Chery International.

Authorized Chery Dealer Service

Only Original Equipment Manufacturer (OEM) parts and materials can extend your vehicle's life. Chery Automobile Co., Ltd. only supplies OEM parts to authorized Chery dealers located world wide. Therefore, only use authorized OEM parts from an authorized Chery dealer.

Authorized Chery dealers are service professionals and are exclusively authorized by Chery Automobile Co., Ltd. For vehicle service, remember that your authorized dealer knows

your vehicle best, has the factory - trained technicians and OEM parts to best provide the customer satisfaction that you require.

After-Sales Service Department Chery International

The following is the address, zip code, E-mail, website and telephone hotline number of the After-Sales Service Department Chery International:

**Address: After-Sales Service Department
Chery International,
No.8, Changchun Road,
Economic & Technical
Development Zone, Wuhu,
Anhui Province, China**

Zip Code: 241009

E-mail: helpdesk@mychery.com

Website: www.cheryinternational.com

Hotline: +86-553-5923830

Any communication sent to the After-Sales Service Department Chery International should include the following information:

- Owner's name and address
 - Owner's telephone number
 - Owner's E-mail
 - Selling and servicing dealer
 - Vehicle Identification Number (VIN)
- Vehicle's delivery date and current odometer reading
 - Service history of your vehicle
 - An accurate description of the problem and the conditions under which it occurs.

PROPER MAINTENANCE OF YOUR VEHICLE

CONTENTS

▶ Proper Maintenance Of Your Vehicle	112	▷ RHD Engine Compartment	114	▷ Fluids, Lubricants, and Genuine Parts	125
▷ Engine Compartment - 1.6L / 1.8L / 2.0L	112	▷ Maintenance Procedures	115	▷ Vehicle Weight	126
▷ Engine Compartment - 2.4L	113	▷ Bulb Replacement	121	▷ Vehicle Dimensions	127
		▷ Fluids and Capacities	124		

Proper Maintenance Of Your Vehicle

Engine Compartment - 1.6L / 1.8L / 2.0L

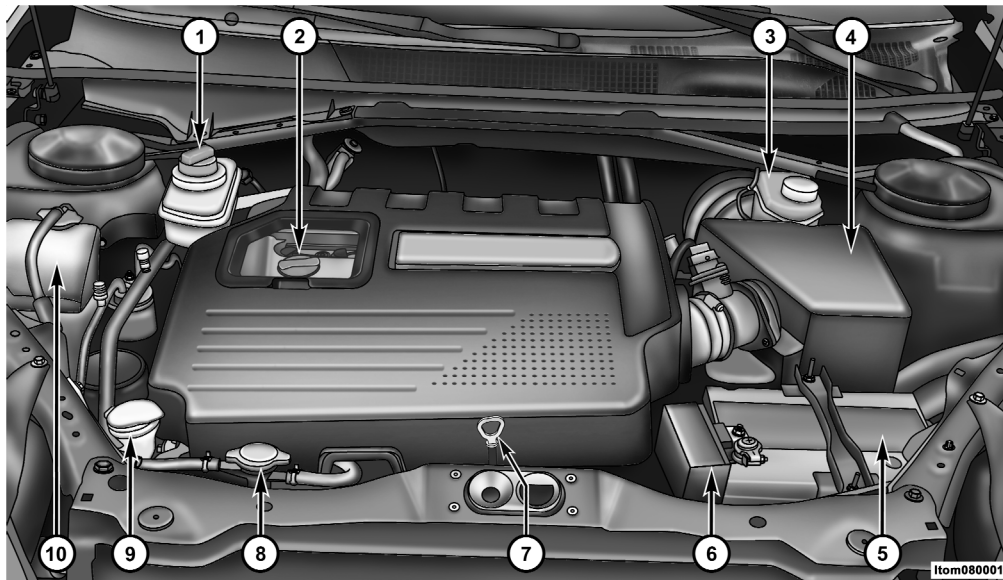

- 1 - Power Steering Fluid Reservoir
- 2 - Engine Oil Fill
- 3 - Brake Fluid Reservoir
- 4 - Air Cleaner Filter
- 5 - Battery

- 6 - Power Fuse Box
- 7 - Engine Oil Dipstick
- 8 - Cooling System Pressure Cap
- 9 - Washer Fluid Bottle
- 10 - Engine Coolant Reservoir

Engine Compartment - 2.4L

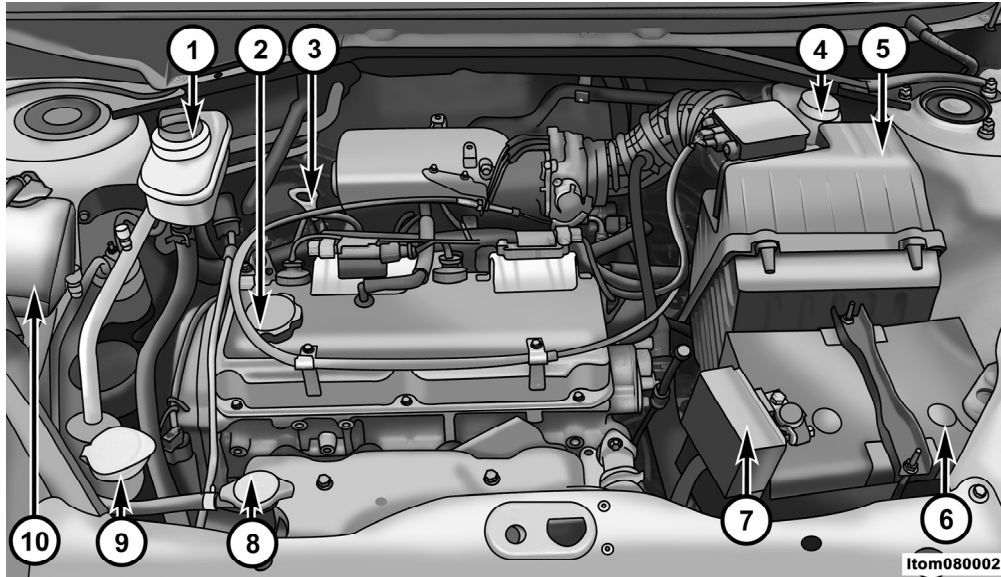

- 1 - Power Steering Fluid Reservoir
- 2 - Engine Oil Fill
- 3 - Engine Oil Dipstick
- 4 - Brake Fluid Reservoir
- 5 - Air Cleaner Filter

- 6 - Battery
- 7 - Power Fuse Box
- 8 - Cooling System Pressure Cap
- 9 - Washer Fluid Bottle
- 10 - Engine Coolant Reservoir

RHD Engine Compartment

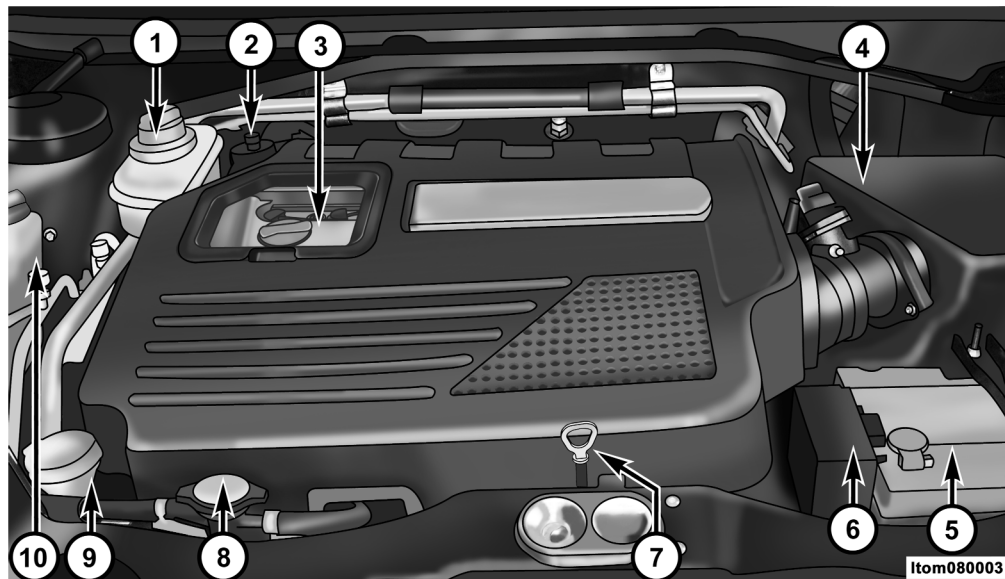

- 1 - Power Steering Fluid Reservoir
- 2 - Brake Fluid Reservoir
- 3 - Engine Oil Fill
- 4 - Air Cleaner Filter
- 5 - Battery

- 6 - Power Fuse Box
- 7 - Engine Oil Dipstick
- 8 - Cooling System Pressure Cap
- 9 - Washer Fluid Bottle
- 10 - Engine Coolant Reservoir

Maintenance Procedures

The pages that follow contain the required maintenance services, determined by the engineers who designed your vehicle. Along with the items which require maintenance at periodic intervals, there are items that should operate satisfactorily without regular maintenance. However, if a malfunction of any of these items should occur, it could adversely affect the engine or vehicle performance. These items should be inspected if a malfunction occurs or is suspected.

NOTE:

- Always wash vehicles in a proper location, using caution not to destroy the ecological drainage system.
- Used engine oil, brake fluid, coolant, batteries and tires should only be disposed of by qualified waste disposal personnel or consult the supply manufacturer. Do not dispose of them

as household waste or drain any chemicals into the public drainage system.

Engine Oil Level Check

Engine oil consumption depends on many factors. A new engine's oil consumption will reach a normal level after its first 5,000 km. The engine will also consume more oil when it is operated while carrying or towing a heavy load.

To assure proper engine lubrication, the engine oil must be maintained at the correct level. Check the oil level at regular intervals, such as every fuel stop.

The best time to check the oil level is approximately five minutes after a fully warmed engine is shut off. Check the oil when the vehicle is on level ground and only while the engine is hot. This will improve the accuracy of the oil level readings. Maintain the oil level between the "MIN" and "MAX"

range markings on the dipstick. Add the correct engine oil when the reading is at the low end of the range marking.

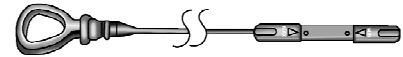

beom080003

Engine Oil Dipstick - 1.6L / 1.8L / 2.0L



Item080004

Engine Oil Dipstick - 2.4L

CAUTION!

Do not overfill the engine oil. Overfilling will cause oil aeration, which can lead to a loss of oil pressure and an increase in oil temperature. This could damage your engine. Also, be sure the oil fill cap is replaced and tightened after adding oil.

Engine Oil Additives

The manufacturer strongly recommends against the addition of any additives (other than leak detection dyes) to the engine oil. Engine oil is an engineered product and its performance may be impaired by supplemental additives.

Disposing of Used Engine Oil

Care should be taken in disposing of used engine oil from your vehicle. Used oil, indiscriminately discarded, can present a problem to the environment. Contact your authorized Chery dealer, service station, or government

agency for advice on how and where used oil can be safely discarded in your area.

Engine Oil Filter

The engine oil filter should be replaced at every engine oil change.

Catalytic Converter

The catalytic converter requires the use of unleaded fuel only. Leaded gasoline will destroy the effectiveness of the catalyst as an emissions control device. Under normal operating conditions, the catalytic converter will not require maintenance. However, it is important to keep the engine properly tuned to assure proper catalyst operation and prevent possible catalyst damage.

CAUTION!

Damage to the catalytic converter can occur if your vehicle is not kept in proper operating condition. In the event of engine malfunction, particularly involving engine misfire or other apparent loss of performance, have your vehicle serviced promptly. Continued operation of your vehicle with a severe malfunction could cause the converter to overheat, resulting in possible damage to the converter and the vehicle.

⚠ WARNING!

A hot exhaust system can start a fire if you park over material that can burn. Such materials, such as grass or leaves coming into contact with your exhaust system could start a fire. Do not park or operate your vehicle in areas where your exhaust system can contact anything that can burn.

Brake Fluid Level Check

Check the fluid level in the master cylinder whenever performing underhood services. The fluid level should be between the "MIN" and "MAX" indicator on the reservoir. If necessary, add fluid to the reservoir to raise the fluid to the proper level.

Adding Brake Fluid

- Check the fluid level in the master cylinder immediately if the brake system warning light indicates a system failure.

- Overfilling fluid is not recommended because it may cause leaking in the system.
- Use only brake fluid that has been stored in a tightly closed container to avoid contamination from foreign matter or moisture.
- Only use brake fluid that meets Chery specifications. Refer to "Fluids and Capacities" in this chapter for the brake fluid capacity and type.

CAUTION!

Do not allow petroleum based fluid to contaminate the brake fluid, brake seal components could be damaged causing partial or complete brake failure.

⚠ WARNING!

Never allow brake fluid to contact your skin or eyes. If brake fluid splashes in your eyes, or on your skin, flush the area immediately with large amounts of water and seek medical treatment immediately.

Coolant Level Check

⚠ WARNING!

Never add coolant when the engine is overheated. Do not loosen or remove the cap to cool an overheated engine. Heat causes pressure to build up in the cooling system. Therefore, to prevent scalding or injury, do not remove the cap while the system is hot or under pressure.

The coolant bottle provides a quick visual method for determining that the coolant level is adequate. With the engine idling and warmed to normal op-

erating temperature, the level of the coolant should be between the "MIN" and "MAX" lines shown on the bottle.

⚠ WARNING!

Coolant is a toxic fluid. If the coolant comes into contact with skin or eyes, immediately wash the affected area with abundant water and seek medical attention.

Adding Coolant

- Remove the coolant reservoir cap and add coolant to the "MAX" indicated mark. Start and run the engine until the coolant temperature reaches approximately 90° C. At that time, the coolant level will drop down in the reservoir.
- Turn the engine off, add more coolant to the coolant reservoir as needed, and repeat the above process until the coolant level does not

drop down any more. After that, install the coolant reservoir cap.

- Only use coolant that meets Chery specifications.

NOTE: Do not mix coolant types for your vehicle.

Power Steering Fluid Check

Checking the power steering fluid level at a defined service interval is not required. The fluid should only be checked if a leak is suspected, abnormal noises are apparent, and/or the system is not functioning as designed. If necessary, add fluid to restore to the proper indicated level. With a clean cloth, wipe any spilled fluid from all surfaces.

Maintenance-Free Battery

You will never have to add water, nor is periodic maintenance required for this battery. It is recommended not to use any other type of battery. The current and capacity of the replacement battery must be the same as the origi-

nal battery, and it must meet Chery specifications. Please consult your authorized Chery dealer for the correct battery specification.

⚠ WARNING!

- **Battery fluid is a corrosive acid solution and can burn or even blind you. Never allow battery fluid to contact your eyes, skin, or clothing. Never lean over a battery when attaching battery charger clamps. If acid splashes in eyes or on skin, flush the area immediately with large amounts of water. Seek medical treatment immediately if battery acid is swallowed.**

(Continued)

⚠ WARNING! (Continued)

- Battery gas is flammable and explosive. Keep flame or sparks away from the battery. The battery used for boosting must be 12 volts. Never allow battery cable clamps to touch each other.
- Keep children away from battery fluid.
- The ignition system uses high voltage. Never touch any ignition system components when the engine is running.

Windshield Washer Fluid Check

The windshield washer fluid reservoir is located in the engine compartment. Be sure to check the reservoir fluid level at regular intervals. Fill the reservoir with windshield washer solvent and operate the system for a few seconds to flush out the residual water.

Windshield Wiper Blades

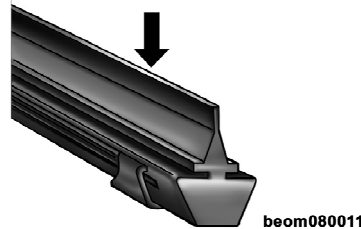

Wiper Blades

Operating the wipers on dry glass for long periods may deteriorate the wiper blades. Always include washer fluid when using the wipers to remove salt or dirt from a dry windshield. Avoid using the wiper blades to remove frost or ice from the windshield. To avoid damaging the wiper blades, make sure that the wipers are not frozen to the glass before turning them on.

NOTE: Always keep the rubber blade free from contact with petroleum products such as engine oil, gasoline, etc.

Wiper Blade Replacement

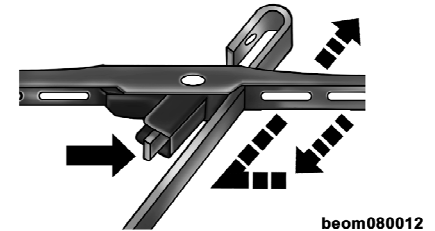

Replacing Wiper Blades

Lift the wiper arm and rotate the wiper blade at a right angle with the wiper arm. Press the release tab (arrow) in the direction as shown in the figure to loosen the wiper blade from the wiper arm. With the release tab pressed, slide the wiper blade away from the wiper arm. Install the new wiper blade in the reverse order, and confirm the release tab is locked securely.

Washing

Wash your vehicle regularly. Always wash your vehicle in the shade with

mild car washing soap. Rinse the vehicle completely with clean water. Avoid using abrasive compounds and power buffing as these may diminish the gloss or thin out the paint finish.

CAUTION!

Observe the following guidelines when washing your vehicle:

- Do not use abrasive or strong cleaning materials such as steel wool or scouring powder, which will scratch metal and painted surfaces.
- After washing, drive the vehicle and depress the brake pedal gently several times to dry the brake rotor.

Special Care

- If you drive on dirt roads, wash off the undercarriage at least once a month.
- If you detect any stone chips or scratches in the paint, touch them up immediately.

- If your vehicle is damaged due to an accident or similar cause, which destroys the paint and protective coating, have your vehicle repaired as soon as possible.
- If regularly driving on gravel roads, consider installing mud/stone guards on the vehicle.

Wheel and Wheel Trim Care

All wheels and wheel trim, especially aluminum and chrome-plated wheels, should be cleaned regularly with a mild soap and water to prevent corrosion. Do not use oven cleaner. Avoid automatic car washes that use acidic solutions or harsh brushes that may damage the wheels' protective finish.

Cleaning Cloth

In order to achieve the best results, always use a soft cleaning cloth for proper vehicle care.

Cleaning Leather Upholstery

Your leather upholstery can be best preserved by regular cleaning with a

damp soft cloth. Small particles of dirt can act as an abrasive and damage the leather upholstery and should be removed promptly with a damp cloth. Care should be taken to avoid soaking your leather upholstery with any liquid.

⚠ WARNING!

Do not use volatile solvents for cleaning purposes. Many are potentially flammable, and if used in closed areas they may cause respiratory harm.

Cleaning Headlights

Your vehicle has plastic headlights that are lighter and less susceptible to stone breakage than glass headlights. Do not use abrasive cleaning components, solvents, steel wool or other aggressive material to clean the lenses.

Cleaning Rear Window

The rear window can be cleaned with a damp, soft cloth. Do not use abrasive

cleaning components, solvents, steel wool or other such material to clean the rear window.

Cleaning Radiator

Over time, the engine radiator and air conditioning condenser can become blocked by insects, leaves and other objects. This debris can block the flow of air to these components and affect the performance of the cooling system and the air conditioner, causing abnormal air conditioner operation and engine overheating. To provide the most efficient cooling system and air conditioner operation, periodic cleaning should be performed on the radiator and condenser. It is recommended to clean the radiator and condenser cooling fins once every year. The radiator may be cleaned with compressed air or water. The condenser may be cleaned with compressed air or water from the rear to the front through the radiator.

CAUTION!

High pressure can damage the radiator fins, the air or water pressure should not exceed 150 kPa.

WARNING!

The radiator fins are necessary for proper thermal conduction. Do not brush the fins, which may damage the fins and reduce the thermal conduction efficiency.

Do not spray water on a HOT radiator, the hot steam produced from spraying the radiator will cause injuries.

Clean the radiator and condenser only when the engine is turned off.

Bulb Replacement

NOTE: All inside bulbs are brass or glass wedge base. Aluminum base bulbs are not approved and should not be used for replacement.

Light Bulb Wattage Ratings

Light Bulb Name	Wattage Rating
Headlight	55 W
Front Fog Light	55 W
Parking Light	5 W
Rear Tail Light/Stop Light	5 W / 21 W
Rear Fog Light	21 W
License Light	5 W
Center High Mounted Stop Light	21 W
Side Repeater Light	5 W
Turn Signal Light	21 W
Backup Light	21 W

Headlight Replacement

- Raise the hood and locate the connector behind the headlight.

- Rotate the applicable bulb and connector and pull outward from the assembly.

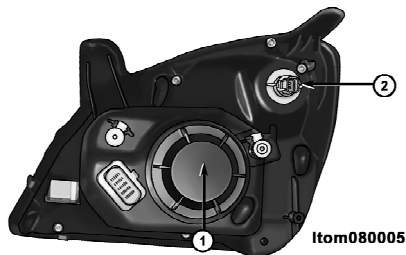

1 - High Beam Headlight / Low Beam Headlight / Parking Light Bulb
2 - Front Turn Signal Bulb

- Pull the bulb out of the socket and replace the bulb.
- Reinsert the bulb and socket assembly and rotate it to the lock position.

CAUTION!

Do not touch the new bulb with your fingers. Oil contamination will severely shorten bulb life.

Headlight Beam Adjustment

The correct headlight adjustment is directly correlated to driving safety. The headlights must be adjusted properly using special instruments. Always follow legal guidelines when adjusting the headlights.

Front Fog Light Replacement

- To replace the front fog light bulb, raise the vehicle and remove the bulb from the back of the fog light.

Side Repeater Light Replacement

NOTE: Side Repeater Lights are located in both front fender panels.

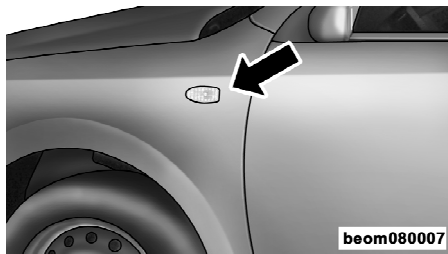

Side Repeater Light Location

- Push the side repeater to one side to release the spring tension and pull outward.
- Twist the socket one quarter turn and pull the socket from the lens.
- Pull the bulb straight from the socket and replace.

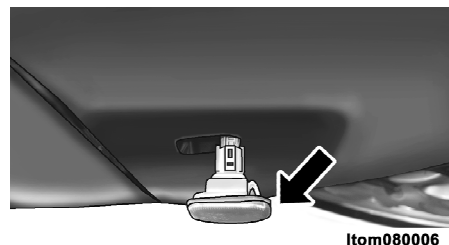

Side Repeater Bulb Removal

Taillight Assembly Bulb Replacement

The taillight assembly contains the following bulbs:

- Rear taillight
- Stop light
- Turn signal light

- Backup light



Taillight Assembly

- Open the back cargo door, loosen the retaining clip of the taillight assembly cover and remove the taillight assembly.
- Remove the light socket from the taillight assembly.
- Push the bulb down with slight pressure and rotate the bulb counter-clockwise.
- Install in the reverse order.

- Verify light operation after reassembly.

Center High-Mounted Stop Light Replacement

- Open the back cargo door and remove the center high-mounted stop light cover.

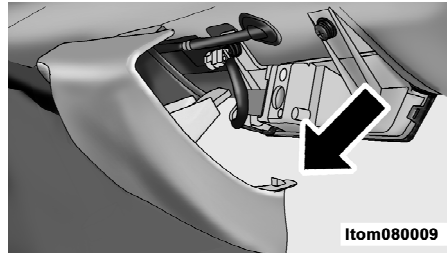

Removing Center High-Mounted Stop Light Cover

- Remove the two screws and pull the bulb out of the socket and replace the bulb.

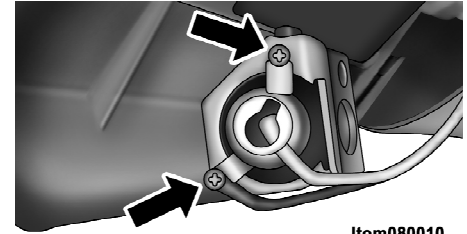

Removing Retaining Screws

- Replace the bulb and reinstall the socket into the housing.
- Install in the reverse order.

License Plate Light Replacement

- Gently pry the light assembly loose.
- Twist the socket one quarter turn and remove the socket from the lens housing.
- Pull the bulb straight from the socket and replace.

Fluids and Capacities

Description		Capacity
Fuel Tank (all engines)		57.0L (approximate)
Fuel Selection		93 Research Octane Number (RON)
Engine Oil with Filter (all engines)	MITSUBISHI (2.0L / 2.4L)	4.3L
	ACTECO (1.6L / 1.8L / 2.0L)	4.5L
Manual Transaxle		2.2L
Automatic Transaxle	DP0	6.0L
	F4A4	6.5L
Transfer Case		0.8L
Rear Final Drive		0.8L
Power Steering Reservoir		"MAX" Mark
Brake/Clutch Master Cylinder		"MAX" Mark
Cooling System		7.5L
Tire Pressure		Refer to tire placard on driver's door.
Washer Fluid Bottle		"MAX" Mark

Fluids, Lubricants, and Genuine Parts

Component		Fluids, Lubricants, and Genuine Parts
Engine Coolant		Use engine coolant that meets Chery specifications. See an authorized Chery dealer for Chery original equipment engine coolant.
Engine Oil		Use SAE 10W-40 (>-20°C) Engine Oil
Spark Plugs	ACTECO (1.6L / 1.8L / 2.0L)	(NGK) FR7DTC
	MITSUBISHI - 2.0L	BKR5E-11/K16PR-U11/K6RF-11
	MITSUBISHI - 2.4L	BKR6E-11/K20PR-U11/K7RF-11
Manual Transaxle Oil		Use composite gear oil API GL-4 for transaxle lubricating oil. The viscosity of the gear oil is SAE 75W-90.
Brake Master Cylinder Fluid		Use DOT 4 brake fluid, and add to "MAX" mark depending on the demand. Only use olefin-free brake fluid.
Transfer Case Oil		Use oil that meets Chery specifications. See an authorized Chery dealer for Chery original equipment transfer case oil.
Rear Final Drive Oil		Use oil that meets Chery specifications. See an authorized Chery dealer for Chery original equipment rear final drive oil.
Washer Fluid		Fill the washer fluid reservoir with concentrated window washer fluid designated by Chery and water (1:20). Always use winter window washer fluid when exterior temperatures are low.

126 – PROPER MAINTENANCE OF YOUR VEHICLE

Vehicle Weight

Vehicle Model		1.6L M/T	1.8L M/T	2.0L M/T	2.0L A/T	2.4L M/T	2.4L M/T+4WD	2.4L A/T
Vehicle Curb Weight		1375 kg	1390 kg	1375 kg	1395 kg	1380 kg	1475 kg	1400 kg
Vehicle Curb Axle Weight	Front Axle	770 kg	785 kg	770 kg	780 kg	775 kg	825 kg	785 kg
	Rear Axle	605 kg	605 kg	605 kg	615 kg	605 kg	650 kg	615 kg
Manufacturer Maximum Loaded Weight (Including Passengers)		375 kg	375 kg	375 kg	375 kg	375 kg	375 kg	375 kg
Manufacturer Maximum Weight		1750 kg	1765 kg	1750 kg	1770 kg	1755 kg	1850 kg	1775 kg
Manufacturer Maximum Total Axle Weight	Front Axle	885 kg	900 kg	885 kg	895 kg	890 kg	910 kg	900 kg
	Rear Axle	865 kg	865 kg	865 kg	875 kg	865 kg	940 kg	875 kg
Manufacturer Maximum Allowable Axle Weight	Front Axle	1000 kg						
	Rear Axle	1200 kg						
Quantity of Occupants (Including Driver)		5						

Vehicle Dimensions

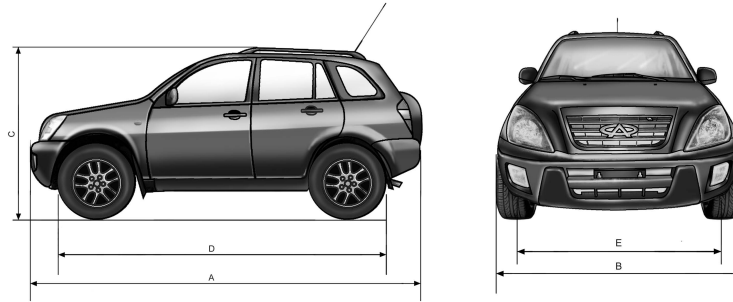

Item080008

Item		Dimension
A = Max Length		4285 mm
B = Full Width		1765 mm
C = Full Height (Curb Weight)		1705 mm
D = Wheel Base		2510 mm
E = Wheel Track	Front	1505 mm
	Rear	1505 mm
Suspension Length	Front	750 mm
	Rear	1025 mm

MAINTENANCE SCHEDULES

CONTENTS

► Maintenance Schedules	130	▷ Care and Maintenance Certificate	137
▷ Periodic Care and Maintenance Provision	130	▷ Safety Protection System	143

Maintenance Schedules

There is a maintenance schedule that shows the **required** service for your vehicle.

CAUTION!

Failure to perform the required maintenance items may result in damage to the vehicle.

Daily Check

- Inspect the working condition of all the exterior and interior lights. Replace any bulbs that are inoperable or dim, and verify all lenses are clean.

At Each Stop for Fuel

- Check the engine oil level about 5 minutes after a fully warmed engine

is shut off. Checking the oil level while the vehicle is on level ground will improve the accuracy of the oil level reading. Add oil only when the level is at or below the "MIN" mark.

- Check the windshield washer solvent and add if required.

Once A Month

- Check the tires for proper tire pressure and look for unusual wear or damage.
- Inspect the battery, and clean and tighten the terminals as required.
- Check the fluid levels of the coolant reservoir and brake master cylinder, and add as needed.
- Check all lights and all other electrical items for correct operation.

- Check rubber seals on each side of the radiator for proper fit.

At Each Oil Change

- Change the engine oil filter.
- Inspect the exhaust system.
- Inspect the brake hoses.
- Inspect the CV joints and front and rear suspension components.
- Check the coolant level, hoses, and clamps.

Periodic Care and Maintenance Provision

See an authorized Chery dealer for care and maintenance in accordance with the specified mileage.

Care and Maintenance Item	Mileage		
	Every 5,000 km	Every 15,000 km	Every 30,000 km
Lights, Warning Flasher, Horn: Check operation		X	X
Windshield Wiper And Washer System: Check operation and fill washer fluid if necessary		X	X
Check Clutch Free Travel And Clutch Oil Level: Adjust if necessary		X	X
Cooling System: Check coolant level and replace if necessary	X	X	X
Engine Oil: Replace	X	X	X
Engine Oil Filter: Replace	X	X	X
Engine: Check for fluid leaks (engine oil, antifreeze fluid, fuel, air conditioner system etc.)	X	X	X
Battery: Check electrolyte fluid level and add distilled water if necessary (for non maintenance-free battery only)		X	X
Timing Belt: Check condition and tightness and adjust or replace if necessary			X
Hood Hinges And Lock: Lubricate	X	X	X
Door Hinges And Door Locks: Lubricate	X	X	X

132 – MAINTENANCE SCHEDULES

Care and Maintenance Item	Mileage		
	Every 5,000 km	Every 15,000 km	Every 30,000 km
Spark Plugs: Check and replace if necessary		X	X
Air Cleaner: Clean housing and filter, replace filter if necessary	X	X	X
Ignition Timing: Check	X	X	X
Fuel Filter: Replace			X
Exhaust System: Check for leaks and damage		X	X
Drive Belt: Check tightness, adjust or replace if necessary		X	X
Transmission: Check for leaks or damage		X	X
Constant Velocity (CV) Universal Joint Boot: Check for damage	X	X	X
Tie Rod End: Check the clearance and boot for damage	X	X	X
Steering Universal Joint Assembly Bushing: Check for displacement or damage		X	X
Power Steering System: Check power steering fluid level and whether the clearance between the steering gear and rack is reasonable		X	X
Brake System: Visually examine for leaks, damage and brake fluid level	X	X	X

Care and Maintenance Item	Mileage		
	Every 5,000 km	Every 15,000 km	Every 30,000 km
Parking Brake: Check the stroke (5 to 7 clicks) and adjust if necessary	X	X	X
Brake Lining: Check its thickness and replace if necessary	X	X	X
Underbody protection layer: Visually examine for damage			X
Seat Belt: Check for damage		X	X
Toe-In And Camber Angle: Check and adjust if necessary		X	X
Ball Joint: Check clearance		X	X
Rear Axle Rubber Bushings: Check for damage		X	X
Engine Oil Pan Bolts: Check for proper torque and tighten if necessary			X
Control Arm Rubber Sleeve: Check for damage		X	X
Brake Hose: Check for aging and damage		X	X
Brake Pipe: Check for damage, corrosion and leaks of all the joints		X	X
Fuel System Connections: Check for aging, damage, abnormal loose or abrasion			X

134 – MAINTENANCE SCHEDULES

Care and Maintenance Item	Mileage		
	Every 5,000 km	Every 15,000 km	Every 30,000 km
Tires (including spare tire): Check tire tread depth, torque of wheel nuts, adjust tire pressure if necessary	X	X	X
Tire Rotation		X	X
Bolts Connecting Chassis And Car Body: Check torque and tighten if necessary	X	X	X
Wheel: Check torque	X	X	X
CO Content During Idle: Check and adjust if necessary	X	X	X
Test Drive: Check whether all the mechanisms function normally	X	X	X
<ul style="list-style-type: none"> • For manual transaxle equipped vehicles, the transaxle gear oil should be replaced every year or every 30,000 km. • The brake fluid should be replaced every 2 years or every 50,000 km. • The engine timing belt should be replaced every 40,000 km. 			

FIRST 5,000 KM CARE & MAINTENANCE CARD

Date: _____

Mileage: _____

Registration
No. of Vehicle: _____

Service Station Seal:

Owner's Signature: _____



Service Station Seal
Vehicle Data

VIN _____

Engine No./Transmission No. _____

Optional Equipment _____

Owner: _____

Address: _____

Telephone Number: _____

Private _____

Business _____

E-Mail: _____

Delivery Date: _____

Registration _____

No. of Vehicle: _____

FIRST 5,000 KM CARE & MAINTENANCE CARD

Date: _____ Mileage: _____

CheckItem:	Y	N	CheckItem:	Y	N
1. Check lubricating system, cooling system and fuel system for leaks.	<input type="checkbox"/>	<input type="checkbox"/>	10. Check generator and air conditioner belt tightness and adjust it if necessary.	<input type="checkbox"/>	<input type="checkbox"/>
2. Replace engine oil and engine oil filter.	<input type="checkbox"/>	<input type="checkbox"/>	11. Check engine hood hinge and lock.	<input type="checkbox"/>	<input type="checkbox"/>
3. Check coolant level and add coolant or adjust coolant concentration if necessary.	<input type="checkbox"/>	<input type="checkbox"/>	12. Check air conditioner for leaks.	<input type="checkbox"/>	<input type="checkbox"/>
4. Check transaxle for leaks.	<input type="checkbox"/>	<input type="checkbox"/>	13. Check transaxle oil level and add oil if necessary.	<input type="checkbox"/>	<input type="checkbox"/>
5. Check tie rod for damage.	<input type="checkbox"/>	<input type="checkbox"/>	14. Check power steering for leaks and add power steering oil.	<input type="checkbox"/>	<input type="checkbox"/>
6. Check transaxle shaft constant velocity universal joint boot for damage.	<input type="checkbox"/>	<input type="checkbox"/>	15. Check the steering universal joint boot.	<input type="checkbox"/>	<input type="checkbox"/>
7. Check brake fluid for leaks and brake pipe for damage.	<input type="checkbox"/>	<input type="checkbox"/>	16. Check whether all the gears of manual transaxle shift smoothly.	<input type="checkbox"/>	<input type="checkbox"/>
8. Check whether all the brake calipers work effectively.	<input type="checkbox"/>	<input type="checkbox"/>	17. Check bolt connecting chassis and car body for proper torque.	<input type="checkbox"/>	<input type="checkbox"/>
9. Check tire pressure and adjust if necessary.	<input type="checkbox"/>	<input type="checkbox"/>			

Care and Maintenance Certificate

PERIODIC CARE AND MAINTENANCE

Perform 5,000 km care and maintenance items after driving 10,000 km or 6 months after last care and maintenance.

Date: _____

Mileage: _____

Service Station Seal

Owner Signature

Next scheduled care and maintenance time or mileage:

Date: _____

Mileage: _____

PERIODIC CARE AND MAINTENANCE

Perform 15,000 km care and maintenance items after driving 15,000 km or 6 months after last care and maintenance.

Date: _____

Mileage: _____

Service Station Seal

Owner Signature

Next scheduled care and maintenance time or mileage:

Date: _____

Mileage: _____

PERIODIC CARE AND MAINTENANCE

Perform 5,000 km care and maintenance items after driving 20,000 km or 6 months after last care and maintenance.

Date: _____

Mileage: _____

Service Station Seal

Owner Signature

Next scheduled care and maintenance time or mileage:

Date: _____

Mileage: _____

Perform periodic care and maintenance in accordance with the items specified in the technical care and maintenance of Tiggo.

PERIODIC CARE AND MAINTENANCE

Perform 5,000 km care and maintenance items after driving 25,000 km or 6 months after last care and maintenance.

Date: _____

Mileage: _____

Service Station Seal

Owner Signature

Next scheduled care and maintenance time or mileage:

Date: _____

Mileage: _____

PERIODIC CARE AND MAINTENANCE

Perform 30,000 km care and maintenance items after driving 30,000 km or 6 months after last care and maintenance.

Date: _____

Mileage: _____

Service Station Seal

Owner Signature

Next scheduled care and maintenance time or mileage:

Date: _____

Mileage: _____

PERIODIC CARE AND MAINTENANCE

Perform 5,000 km care and maintenance items after driving 35,000 km or 6 months after last care and maintenance.

Date: _____

Mileage: _____

Service Station Seal

Owner Signature

Next scheduled care and maintenance time or mileage:

Date: _____

Mileage: _____

Perform periodic care and maintenance in accordance with the items specified in the technical care and maintenance of Tiggo.

PERIODIC CARE AND MAINTENANCE

Perform 5,000 km care and maintenance items after driving 40,000 km or 6 months after last care and maintenance.

Date: _____

Mileage: _____

Service Station Seal

Owner Signature

Next scheduled care and maintenance time or mileage:

Date: _____

Mileage: _____

PERIODIC CARE AND MAINTENANCE

Perform 15,000 km care and maintenance items after driving 45,000 km or 6 months after last care and maintenance.

Date: _____

Mileage: _____

Service Station Seal

Owner Signature

Next scheduled care and maintenance time or mileage:

Date: _____

Mileage: _____

PERIODIC CARE AND MAINTENANCE

Perform 5,000 km care and maintenance items after driving 50,000 km or 6 months after last care and maintenance.

Date: _____

Mileage: _____

Service Station Seal

Owner Signature

Next scheduled care and maintenance time or mileage:

Date: _____

Mileage: _____

Perform periodic care and maintenance in accordance with the items specified in the technical care and maintenance of Tiggo.

PERIODIC CARE AND MAINTENANCE

Perform 5,000 km care and maintenance items after driving 55,000 km or 6 months after last care and maintenance.

Date: _____

Mileage: _____

Service Station Seal

Owner Signature

Next scheduled care and maintenance time or mileage:

Date: _____

Mileage: _____

PERIODIC CARE AND MAINTENANCE

Perform 30,000 km care and maintenance items after driving 60,000 km or 6 months after last care and maintenance.

Date: _____

Mileage: _____

Service Station Seal

Owner Signature

Next scheduled care and maintenance time or mileage:

Date: _____

Mileage: _____

PERIODIC CARE AND MAINTENANCE

Perform 5,000 km care and maintenance items after driving 65,000 km or 6 months after last care and maintenance.

Date: _____

Mileage: _____

Service Station Seal

Owner Signature

Next scheduled care and maintenance time or mileage:

Date: _____

Mileage: _____

Perform periodic care and maintenance in accordance with the items specified in the technical care and maintenance of Tiggo.

PERIODIC CARE AND MAINTENANCE

Perform 5,000 km care and maintenance items after driving 70,000 km or 6 months after last care and maintenance.

Date: _____

Mileage: _____

Service Station Seal

Owner Signature

Next scheduled care and maintenance time or mileage:

Date: _____

Mileage: _____

PERIODIC CARE AND MAINTENANCE

Perform 15,000 km care and maintenance items after driving 75,000 km or 6 months after last care and maintenance.

Date: _____

Mileage: _____

Service Station Seal

Owner Signature

Next scheduled care and maintenance time or mileage:

Date: _____

Mileage: _____

PERIODIC CARE AND MAINTENANCE

Perform 5,000 km care and maintenance items after driving 80,000 km or 6 months after last care and maintenance.

Date: _____

Mileage: _____

Service Station Seal

Owner Signature

Next scheduled care and maintenance time or mileage:

Date: _____

Mileage: _____

Perform periodic care and maintenance in accordance with the items specified in the technical care and maintenance of Tiggo.

PERIODIC CARE AND MAINTENANCE

Perform 5,000 km care and maintenance items after driving 85,000 km or 6 months after last care and maintenance.

Date: _____

Mileage: _____

Service Station Seal

Owner Signature

Next scheduled care and maintenance time or mileage:

Date: _____

Mileage: _____

PERIODIC CARE AND MAINTENANCE

Perform 30,000 km care and maintenance items after driving 90,000 km or 6 months after last care and maintenance.

Date: _____

Mileage: _____

Service Station Seal

Owner Signature

Next scheduled care and maintenance time or mileage:

Date: _____

Mileage: _____

PERIODIC CARE AND MAINTENANCE

Perform 5,000 km care and maintenance items after driving 95,000 km or 6 months after last care and maintenance.

Date: _____

Mileage: _____

Service Station Seal

Owner Signature

Next scheduled care and maintenance time or mileage:

Date: _____

Mileage: _____

Perform periodic care and maintenance in accordance with the items specified in the technical care and maintenance of Tiggo.

Safety Protection System

The airbags must be replaced 10 years from the initial installation date. This must be performed by an authorized Chery dealer.

In order to ensure the proper operation of the airbag system, always have the airbags replaced at the specified date by an authorized Chery dealer.

If the airbags have been replaced before the specified date (such as after an accident), please fill in the replacement record for future reference.

**SAFETY SYSTEM
REPLACEMENT RECORD**

- Driver air bag
- Front passenger side air bag
- Left side air bag
- Right side air bag
- Air bag control module
- Air bag harness
- Pretensioner seat belt
- Other components

- 1. -----
- 2. -----
- 3. -----
- 4. -----
- 5. -----
- 6. -----

Date: -----

Authorized service station seal:

**SAFETY SYSTEM
REPLACEMENT RECORD**

- Driver air bag
- Front passenger side air bag
- Left side air bag
- Right side air bag
- Air bag control module
- Air bag harness
- Pretensioner seat belt
- Other components

- 1. -----
- 2. -----
- 3. -----
- 4. -----
- 5. -----
- 6. -----

Date: -----

Authorized service station seal:

**SAFETY SYSTEM
REPLACEMENT RECORD**

- Driver air bag
- Front passenger side air bag
- Left side air bag
- Right side air bag
- Air bag control module
- Air bag harness
- Pretensioner seat belt
- Other components

- 1. -----
- 2. -----
- 3. -----
- 4. -----
- 5. -----
- 6. -----

Date: -----

Authorized service station seal:

**SAFETY SYSTEM
REPLACEMENT RECORD**

- Driver air bag
- Front passenger side air bag
- Left side air bag
- Right side air bag
- Air bag control module
- Air bag harness
- Pretensioner seat belt
- Other components

1. -----
2. -----
3. -----
4. -----
5. -----
6. -----

Date: -----

Authorized service station seal:

**SAFETY SYSTEM
REPLACEMENT RECORD**

- Driver air bag
- Front passenger side air bag
- Left side air bag
- Right side air bag
- Air bag control module
- Air bag harness
- Pretensioner seat belt
- Other components

1. -----
2. -----
3. -----
4. -----
5. -----
6. -----

Date: -----

Authorized service station seal:

**SAFETY SYSTEM
REPLACEMENT RECORD**

- Driver air bag
- Front passenger side air bag
- Left side air bag
- Right side air bag
- Air bag control module
- Air bag harness
- Pretensioner seat belt
- Other components

1. -----
2. -----
3. -----
4. -----
5. -----
6. -----

Date: -----

Authorized service station seal:

INDEX

A	
ABS Self-Check68
Adding Fuel74
Adjustable Upper Shoulder Belt Anchorage24
Adjusting Steering Wheel20
After Starting60
After-Sales Service Department Chery International109
Air Conditioning and Heating System94
Airbag25
Airbag Warning Light26
Anti-Pinch Feature49
Anti-Pinch Override49
Anti-Theft Security Protection19
Antilock Brake System (ABS)68
Audio System85
Authorized Chery Dealer Service108
Auto - Down Feature22
Automatic Transaxle (If Equipped)62
Automatic Transaxle Manual Shift Mode63
Auxiliary Storage Compartments53

B	
Brake Booster66
Brake Lights46
Brake System65
Braking System Break-In Recommendations31
Bulb Replacement121

C	
Care and Maintenance Certificate137
Cargo Area53
CD Changer Operation91
CD Player Operation90
Center Console52
Central Two-Point Seat Belt for Rear Seat24
Child Restraint26
Child-Protection Door Lock System (Rear Doors)21
Cigarette Lighter50
Cigarette Lighter and Ashtray50
Clean Air Gasoline74
Climate Control93
Clock Setting88
Closing Sunroof49
Cruise Control47

Cruise Control (If Equipped)47
Cup and Bottle Holders51

D	
Dimmer Control45
Door Locks20
Downshifting65
Driving In Slippery Conditions70
Driving Off-Highway With 4WD Vehicles65
Driving Through Water69
Dual Circuit Brake System66

E	
Electrical Power Outlet46
Electronic Key Identification19
Engine Break-In Recommendations30
Engine Compartment - 1.6L / 1.8L / 2.0L112
Engine Compartment - 2.4L113
Exhaust Gas28
Exterior Vehicle Safety Inspection29

F	
Failed Starting Procedure60
Filling The Cartridge93

Flash to Pass44
 Fluids and Capacities124
 Fluids, Lubricants,
 and Genuine Parts125
 Four Wheel Drive (4WD)65
 Four Wheel Drive System
 (If Equipped).65
 Front Ashtray.50
 Front Cupholder.51
 Front Fog Lights (If Equipped)44
 Front Interior Lighting45
 Front Windshield Wipers and
 Washers.37
 Fuel.73
 Fuse Replacement103

G

Gear Ranges62
 General Information70
 General Information73
 General Information85
 General Information92
 General Information93
 Glove Box.52

H

Hazard Warning Flasher98
 Head Restraints42
 Headlight Leveling System.45
 Headlights, Parking Lights
 (Front Position Lights, Instrument
 Panel Lights and License Light)43
 Heated Remote Control Mirrors.36
 Heated Seats (If Equipped)42
 High Beam/Low Beam Select Switch.43
 Hood Release61
 Horn20
 How to Read This Manual4

I

If You Need Assistance.108
 Ignition Key.17
 Ignition Key Removal17
 Index.4
 Inserting The Cartridge93
 Inside Rearview Mirror.35
 Inspection Certification for Vehicle
 Delivery7
 Instrument Cluster80
 Instrument Cluster Functions81
 Instrument Panel Features78

Interior Vehicle Safety Inspection29
 Introduction4

J

Jack Location98
 Jacking and Tire Changing98
 Jacking Instructions99
 Jump-Starting Procedures Due to
 A Low Battery.105

K

Key-In-Ignition Reminder.17
 Keyhole Light46

L

Lap/Shoulder Belt Operating
 Instructions23
 Lap/Shoulder Belt Warning Light23
 Lap/Shoulder Belts23
 LHD Instrument Panel Features.78
 Lights.43
 Locking Doors With The Key.17
 Locking Your Vehicle28

M

Maintenance for Seat Belt24
Maintenance Procedures115
Maintenance Schedules130
Manual Door Locks20
Manual Front Seat Adjustments39
Manual Rear Seat Adjustments40
Manual Transaxle64
Mirrors35

N

New Vehicle Break-In Recommendations30
New Vehicle Inspection6
Normal Starting Procedure59

O

Occupant Restraints23
Opening Sunroof49
Operating Cautions67
Operating Safety Tips28
Outside Mirror35
Outside Mirrors Folding Feature35
Overhead Console52

P

Parking Brake65
Periodic Care and Maintenance Provision130
PERSON-TO-PERSON Service Advisor Card11
Personal Service10
Power Door Locks21
Power Remote Control Mirrors35
Power Steering68
Power Window Switches22
Power Windows22
Preparation Before Starting59
Preparations for Jacking99
Proper Maintenance Of Your Vehicle112

R

Radio Faceplate86
Radio Faceplate Description87
Radio Operation88
Rear Ashtray51
Rear Cupholder51
Rear Fog Lights44
Rear Interior Lighting45
Rear Window Defroster96
Rear Window Defroster (If Equipped)96

Rear Window Safety Switch23
Rear Window Wiper and Washer38
Remote Audio System Controls (If Equipped)91
Remote Keyless Entry18
Remove the Cartridge93
Removing and Installing Vehicle Battery104
Replacement Keys17
Replacement Tires73
Reverse Lights46
RHD Engine Compartment114
RHD Instrument Panel Features79
Roof Luggage Rack55

S

Safety Protection System143
Seats39
Service Appointments108
Service for Your Vehicle108
Service List108
Service Requests108
Shift Lock Feature64
Shifting64
Spare Tire72
Spare Tire Location98
Starting and Operating59

Starting and Operating Cautions60
 Steering Wheel20
 Storage Areas52
 Sunroof (If Equipped)49
 Sunshade Operation50

T

Table of Contents.4
 Tilt Down Feature.49
 Tilt UP Feature.49
 Tire and Wheel Break-In
 Recommendations.31
 Tire Pressure71
 Tire Rotation72
 Tires70
 To Accelerate for Passing48

To Activate47
 To Deactivate48
 To Resume Set Speed48
 To Set A Desired Speed47
 To Vary The Set Speed48
 Towing A Disabled Vehicle104
 Transmitter Battery Replacement.18
 Transporting Passengers.28
 Tread Wear72
 Turn Signals.44

U

Utilizing ABS Braking.68

V

Vanity Mirrors36
 Vehicle Alarm19

Vehicle Delivery Card8
 Vehicle Dimensions.127
 Vehicle Features6
 Vehicle Identification Number.13
 Vehicle Modifications13
 Vehicle Overheating101
 Vehicle Satisfaction108
 Vehicle Symbols4
 Vehicle Weight126

W

Warnings and Cautions13
 Wheel Nut Torque Specification.101
 Windshield Wipers and Washers36